

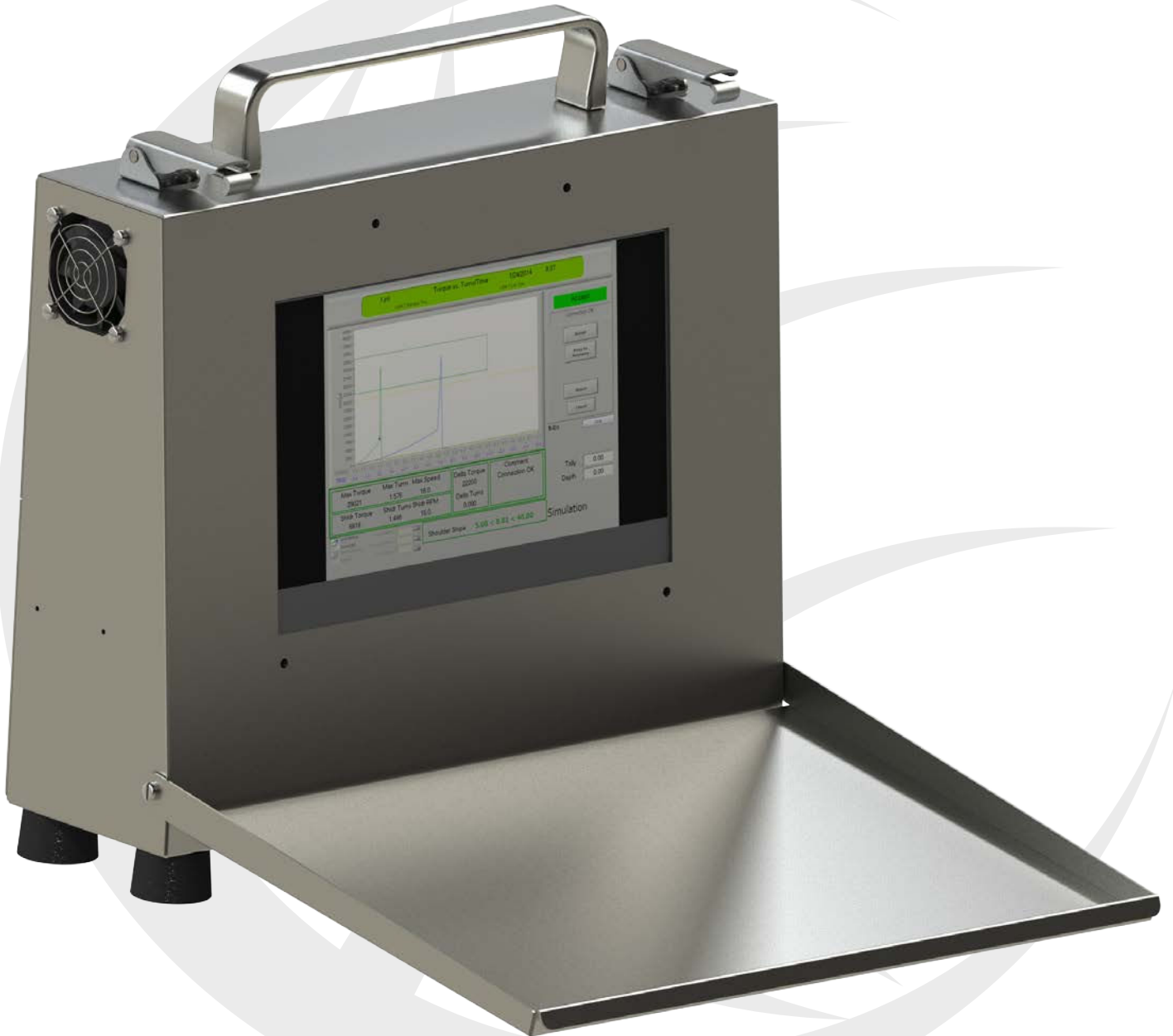

TECHNICAL MANUAL

WINCATT®

Computerized Torque/Turn Management System
Featuring WINCATT® 7 Operating Software



INSTALLATION | PROGRAMMING | OPERATION | MAINTENANCE

MCCOYGLOBAL.COM



ORIGINAL INSTRUCTIONS

This user guide applies to all standard models of this equipment using WinCatt 7 software.

McCoy has made every effort to ensure that all illustrations are accurate, but please note that some illustrations used in this guide may not exactly visually match your equipment.

PATENTED & PATENTS PENDING



**This page intentionally
left blank**

Copyright © 1996 - 2014 McCoy Global, including its wholly owned subsidiaries, (“McCoy”), all rights reserved. This document is the property of McCoy and is supplied as reference information for users of our products. This document and the contents within are considered confidential information, not to be disclosed, copied, transmitted, transcribed in any form, or stored on any type of data storage media without the express written consent of McCoy.

McCoy has made every effort to ensure the information contained in this document is accurate and current. This manual is intended to provide equipment operation and safety instructions for your equipment. However, McCoy does not warrant or guarantee that the information is either complete or accurate in every respect and the user of the manual should consult with its McCoy sales representative for any clarifications and updates.

The user of the manual shall protect, indemnify, and hold harmless McCoy and its directors, officers, employees, and agents from and against all liability for personal injury, death, or property damage resulting directly or indirectly from the use of the information contained in this manual.

Observance of all descriptions, information and instructions set out in this manual is the full responsibility of the user. This manual is intended for guidance and informational purposes and must be used in association with adequate training and on-the-job supervision to provide safe and effective equipment use.

It is the responsibility of the user to conform to all regulations and requirements issued by an authority or agency which may affect the operation, safety or equipment integrity, that may overrule the content of this documentation.

The user will acknowledge and obey any general legal or other mandatory regulation in force relating to accident prevention, safety, and equipment integrity.



**This page intentionally
left blank**

Summary Of Revisions				
Date	Section	Page	Description Of Revision	Approved
NOV 2014	N/A	N/A	Initial Release	R. Bali

SECTION 1: INTRODUCTION

1.0 INTRODUCTION & CONTACT INFORMATION 1.3

1.1 SCOPE..... 1.5

1.2 GENERAL HEALTH AND SAFETY..... 1.7

 1.2.1 Hazard Labels..... 1.7

 1.2.2 General Safe Operation Guidelines..... 1.7

 1.2.3 Maintenance Safety 1.8

 1.2.4 Replacement Parts 1.8

 1.2.5 Environmental Impact 1.8

1.3 ACRONYMS AND TERMINOLOGY..... 1.9

 1.3.1 Acronyms and Definitions 1.9

 1.3.2 Terms and Definitions 1.10

SECTION 2: EQUIPMENT DESCRIPTION & SPECIFICATIONS

2.0 EQUIPMENT DESCRIPTION 2.3

2.1 COMPONENT IDENTIFICATION..... 2.6

2.2 EQUIPMENT SPECIFICATIONS 2.11

SECTION 3: INSTALLATION AND COMMISSIONING

3.0 RECEIPT, INSPECTION, AND HANDLING OF EQUIPMENT 3.3

3.1 EQUIPMENT INSTALLATION AND CONNECTION 3.3

 3.1.1 Standard WINCATT® System Installation 3.3

 3.1.2 WINCATT® Ex System Installation..... 3.8

3.2 WINCATT® SYSTEM INITIALIZATION 3.13

 3.2.1 Standard WINCATT® Start-up..... 3.13

 3.2.2 WINCATT® Ex Start-up 3.14

SECTION 4: PROGRAMMING & CONFIGURATION

4.0 WINCATT® CONNECTION LIBRARY 4.3

4.1 PROGRAMMING A NEW WINCATT® JOB..... 4.5

4.2 HARDWARE TEST & CONFIGURATION..... 4.9

 4.2.1 Selecting & Testing A Load Cell 4.9

 4.2.2 Calibrating Turns Counter Encoder 4.10

 4.2.3 Dump Valve Test 4.13

 4.3.4 Torque Output Test..... 4.14

 4.3.5 Setting System Options 4.15

4.4 RUNNING A JOB 4.18

 4.4.1 Resuming A Previous Job..... 4.18

 4.4.2 Utility Menu 4.22

 4.4.3 Generating A Job Report 4.23

 4.4.4 Printing A Summary Report 4.24

 4.4.5 Bucking Mode 4.25

 4.4.6 Redundant Data Storage 4.30

SECTION 5: MAINTENANCE 5.1

5.0 GENERAL MAINTENANCE SAFETY PRACTICES 5.3

5.1 CLEANING..... 5.3

5.2 INSPECTIONS..... 5.3

5.2 INSPECTIONS (CONTINUED):..... 5.4

5.3 LOAD CELL REFERENCE CHECK..... 5.4

5.4 AIR FILTRATION MAINTENANCE..... 5.6

 5.3.1 Pressure Regulator Maintenance 5.6

 5.3.2 Water Separator..... 5.6

 5.3.3 Oil Coalescing Filter..... 5.6

SECTION 6: PARTS & ASSEMBLIES

Illustration 2.0.1: Standard WINCATT®	2.3
Illustration 2.0.2: ATEX WINCATT®	2.3
Illustration 2.0.3: WINCATT® Enclosure (Standard)	2.4
Illustration 2.0.4: WINCATT® Ex Enclosure	2.5
Illustration 2.1.1: WINCATT® Component Identification 01	2.6
Illustration 2.1.2: WINCATT® Component Identification 02	2.7
Illustration 2.1.3: WINCATT® Component Identification 03	2.8
Illustration 2.1.4: WINCATT® Component Identification 03	2.9
Illustration 2.1.4: WINCATT® Component Identification 04	2.10
Illustration 3.1.1: Dump Valve Installation	3.3
Illustration 3.1.2: Mounting Encoder To Encoder Mount	3.4
Illustration 3.1.3: 60-0001 Encoder Mount Installation Location	3.5
Illustration 3.1.4: Encoder Mount Installation Location	3.5
Illustration 3.1.5: Standard Junction Box Connection (Hydraulic Load Cell)	3.7
Illustration 3.1.6: Standard Junction Box Connection (Electronic Load Cell)	3.7
Illustration 3.1.7: Standard Junction Box Connection (Electronic Load Cell)	3.8
Illustration 3.1.8: WINCATT® Ex Junction Box Connections	3.9
Illustration 3.1.9: CT Cable Connection At WINCATT® Ex Enclosure	3.10
Illustration 3.1.10: Cable Pigtail Connections At WINCATT® Ex Enclosure	3.11
Illustration 3.1.11: WINCATT® Ex Purge Air Filter Assembly	3.11
Illustration 3.1.11: Purge Air Connection - MiniPurge Controller	3.12
Illustration 3.2.1: Power Button Access - Standard WINCATT® Enclosure	3.13
Illustration 3.2.2: MiniPurge Interlock Indicators	3.14
Illustration 4.0.1: WINCATT® 7 Home Screen	4.3
Illustration 4.0.2: WINCATT® 7 Connection Library Screen	4.3
Illustration 4.0.3: WINCATT® 7 Connection Library Screen - Connection Parameters	4.4
Illustration 4.1.1: Invoking Job Selection Menu on Home Screen	4.5
Illustration 4.1.2: Job Management Screen	4.5
Illustration 4.1.3: New Job & Lot Screen	4.6
Illustration 4.1.4: Connection Type Screen	4.7
Illustration 4.1.5: Program Settings Screen	4.7
Illustration 4.1.5: Program Settings Screen	4.8
Illustration 4.2.1: Hardware Screen - Torque Calibration	4.9
Illustration 4.2.2: Load Cell Selection	4.9
Illustration 4.2.3: Turns Counter Calibration 01	4.10
Illustration 4.2.4: Turns Counter Calibration 02	4.11
Illustration 4.2.5: Turns Counter Calibration 03	4.11
Illustration 4.2.6: Turns Counter Calibration 04	4.11
Illustration 4.2.7: Turns Counter Calibration 05	4.12
Illustration 4.2.8: Turns Counter Calibration 06	4.13
Illustration 4.2.9: Testing Dump Valve	4.13
Illustration 4.3.10: Torque Arm & Torque Output	4.14
Illustration 4.3.11: Systems Options Screen	4.15
Illustration 4.3.12: Multi-Joint Review Displayed On DAC Screen	4.16
Illustration 4.3.12: Alternate Graph Zoom Options	4.16
Illustration 4.3.12: Alternate Graph Zoom Displayed On DAC Screen	4.17
Illustration 4.4.1: Resuming A Job From The Home Screen	4.18
Illustration 4.4.2: Running A Job - DAC Screen	4.18
Illustration 4.4.3: WINCATT® Recommends Accepting Connection - DAC Screen	4.19
Illustration 4.4.4: Acceptance Comments - DAC Screen	4.19
Illustration 4.4.5: WINCATT® Recommends Rejecting Connection - DAC Screen	4.20
Illustration 4.4.6: Rejection Comments - DAC Screen	4.20
Illustration 4.4.7: Shoulder Point Select/Zoom - DAC Screen	4.21
Illustration 4.4.8: Shoulder Point Adjustment - Zoom Window	4.21
Illustration 4.4.8: Launching Utility Menu	4.22
Illustration 4.4.9: Launching Job Report	4.23
Illustration 4.4.10: Launching Job Report	4.24
Illustration 4.4.11: WinCatt Data Folder	4.25
Illustration 4.4.12: Enabling Bucking Mode	4.25
Illustration 4.4.13: Bucking Mode Admin/User Modes	4.26
Illustration 4.4.14: Set Up Bucking Mode Screen	4.27
Illustration 4.4.15: Bucking Mode Home Screen	4.27
Illustration 4.4.16: Bucking Mode Hardware/System Options	4.28
Illustration 4.4.17: Bucking Mode Data Acquisition Screen	4.29
Illustration 4.4.18: Setting Redundant Data Storage Path	4.30
Illustration 5.4.1: Supply Air Filter Assembly	5.6



**This page intentionally
left blank**



SECTION 1: INTRODUCTION



**This page intentionally
left blank**

1.0 INTRODUCTION & CONTACT INFORMATION

Congratulations, and thank you for purchasing quality tubular connection equipment from McCoy Global. This unit will provide years of outstanding performance. Proper maintenance and care will extend its life and ensure years of excellent performance and reliability. The installation and commissioning, operating, and maintenance instructions in this manual will assist you in giving your equipment the care it requires. Please read the manual before installing and using your equipment. Replacement parts are readily available from McCoy Global. Should you need replacement parts, or should you experience any difficulty not covered in this manual, please contact:

McCoy Global Canada

14755 121A Avenue
Edmonton, Alberta, Canada
T5L 2T2

Phone: 780.453.3277
Fax: 780.455.2432

McCoy Global USA - Tongs & Bucking Units

4225 HWY 90 East
Broussard, LA, USA
70518

Phone: 337.837.8847
Fax: 337.837.8839

McCoy Global USA - Service

6530 Petropark Drive
Houston, TX, USA
77041

Phone: 281.377.4264
Fax: 281.377.4278

McCoy Global UK Ltd.

Units 9/10 Ocean Trade Center, Minto Avenue, Altens Industrial Estate
Aberdeen, AB12 3JZ
United Kingdom

Phone: +44.1224.245140
Fax: +44.1224.890176

McCoy Global Singapore PTE Ltd.

49 Tuas View Loop
Singapore, 637701
Republic of Singapore

Phone: +44.1224.245140
Fax: +44.1224.890176

Email Sales: dcsales@mccoyglobal.com

www.mccoyglobal.com/tubular-products

Technical manuals are produced and published by McCoy Global Inc.. McCoy Global has made an effort ensure that all information in this document is accurate, but please note that some illustrations used in this manual may not visually match actual purchased equipment. If you believe information in this publication is missing or erroneous, please contact one of our Technical Publications Departments at McCoy Global Canada or McCoy Global USA Tongs & Bucking Units.

Standard Terms and Conditions of Sale (including warranty information):

<http://www.mccoyglobal.com/tcs.pdf>



**This page intentionally
left blank**

1.1 SCOPE

This technical manual is the main document supplied by McCoy Global for the equipment identified on Page iii of the preamble. The intent of this document is to provide descriptions of the systems, installation, commissioning and operating instructions, maintenance guidelines, spare parts information, and technical drawings and schematics (where applicable).

The OEM-recommended installation and commissioning practices, and operation, maintenance, and troubleshooting instructions are to be regarded as guidelines, and are not intended to be a comprehensive operating guide for your specific application. Due to the wide variety of operating conditions it remains the responsibility of each equipment owner to use these guidelines together with an experienced manager to develop safe operating procedures that conform to American Petroleum Institute (or equivalent) standards, applicable State/Province or local regulations, and the regulations and operating practices dictated by your company.



**This page intentionally
left blank**

1.2 GENERAL HEALTH AND SAFETY

AUTHORIZED USE ONLY!**READ THIS MANUAL BEFORE USING EQUIPMENT**

Only authorized, trained, and competent personnel shall operate, maintain, and repair this equipment.

Fully review this manual and comply with all safety and environmental protection instructions before operating equipment.

1.2.1 Hazard Labels

McCoy Global uses four levels of hazard / notice labels to describe items of four levels of importance:

DANGER is represented by a hazard symbol coupled with a “**DANGER**” signal word, and identifies items of the highest level of risk. Failure to heed information identified by a **DANGER** symbol may result in severe bodily injury or death.

**DANGER****THIS IDENTIFIES AN EXTREME HAZARD OF PERSONAL INJURY OR DEATH**

A **WARNING** is represented by a hazard symbol coupled with a bold “**WARNING**” signal word, and identifies items of medium risk. Failure to heed information identified by a **WARNING** symbol may result in significant injury to personnel, catastrophic equipment failure, or harmful environmental contamination.

**WARNING****THIS IDENTIFIES A WARNING REGARDING POTENTIAL INJURY OR CATASTROPHIC EQUIPMENT DAMAGE**

A **CAUTION** is represented by a hazard symbol coupled with a bold “**CAUTION**” signal word, and identifies items of low risk. Failure to heed information identified by a **WARNING** symbol may result in injury to personnel or equipment damage.

**CAUTION****THIS IDENTIFIES A CAUTION REGARDING SAFE OPERATION OR THE POTENTIAL OF EQUIPMENT DAMAGE**

A **NOTICE** highlights information or items of importance unrelated to personal injury that may aid the user during installation, commissioning, assembly, or operation of your equipment.

NOTICE**THIS HIGHLIGHTS ITEMS OF IMPORTANCE UNRELATED TO PERSONAL INJURY**

1.2.2 General Safe Operation Guidelines

Only authorized personnel shall operate equipment delivered by McCoy. Equipment shall be in a proper technical condition prior to use, and shall be used only for the purpose for which it is intended. Malfunctions or damages must be rectified before operation to ensure personnel safety and avoid equipment damage.

The user is responsible for ensuring the safety of all personnel while operating any McCoy product. McCoy is not responsible for injuries or equipment damage that arises from improper use of the equipment.

McCoy recommends that a hazard assessment of the work area be performed by a designated safety representative before commencing operations. A designated safety representative is responsible for verifying that all operators have adequate equipment and safety training.

1.2.2 General Safe Operation Guidelines (Continued):

Always wear all personal protective equipment (PPE) specified by your company's HSE policy, and follow all of your company's safety guidelines.

1.2.3 Maintenance Safety

All personnel are responsible for performing maintenance tasks in a manner that ensures worker, equipment, and environmental safety, and may require taking additional steps that are not identified in this section.

Maintenance of equipment shall be performed only by designated qualified maintenance personnel. Do not begin a maintenance task without the proper tools or materials on hand, or the proper drawings and documentation necessary.

Isolate the location of the maintenance under way to prevent unaware personnel from inadvertently exposing themselves to a hazard. Use tape, rope, or signage to clearly indicate "off-limits" area.

Where applicable ensure electrical circuits within the affected equipment are deactivated or de-energized by an authorized, qualified person and locked out if necessary. Do not disconnect a live electrical circuit unless location is known to be non-hazardous.

**DANGER**

ALWAYS MEASURE ELECTRICAL CIRCUITS TO CONFIRM DEACTIVATION BEFORE PROCEEDING WITH MAINTENANCE

1.2.4 Replacement Parts

All consumable and replacement parts must meet or exceed OEM specifications in order to maintain equipment integrity. Do not replace protective equipment such as hydraulic switches, circuit breakers and fuses without first consulting with McCoy. Do not replace electrical or control hardware without consulting with McCoy Global. Using non-OEM replacement parts without the approval of McCoy Global may void your equipment warranty.

Do not modify or alter any component or assembly on this equipment.

**WARNING**

DO NOT MODIFY OR ALTER ANY COMPONENT OR ASSEMBLY ON THIS EQUIPMENT

1.2.5 Environmental Impact

Your equipment uses materials that may be harmful to the environment if improperly disposed of (hydraulic fluid, grease, fuel, electrical components, etc.). Dispose of all materials according to your company's stated environmental protection regulations and published federal, state, provincial, and civic legislation.

In all cases observance of the following is the full responsibility of the user:

- **all descriptions, information and instructions set out in this manual**
- **any regulation or requirement issued by an authority or agency which may influence operation, safety or integrity of the equipment that overrules the content of this document.**
- **any legal or other mandatory regulation in force governing accident prevention or environmental protection.**

1.3 ACRONYMS AND TERMINOLOGY

1.3.1 Acronyms and Definitions

ACRONYM	DEFINITION
ANSI	American National Standards Institute
API	American Petroleum Institute
ASME	American Society of Mechanical Engineers
ATEX	Appareils destinés à être utilisés en AT mosphères EX plosibles
BDC	Bottom dead centre
CBU	CLINCHER [®] -style backup
CE	Conformité Européenne
CCW	Counter-clockwise
COG	Centre of gravity
CW	Clockwise
DS	Driller's side
EU	European Union
HMI	Human-machine interface
HPU	Hydraulic power unit
HSE	Health, Safety, and Environmental (context: protection)
ID	Inside diameter
ISO	International Organization for Standardization
JDK	Jaw die kit
JSA	Job safety assessment
LH	Left-hand
LJBU	LOCKJAW [™] backup
MBU	"McCoy style" backup
N/A	Not applicable or Not available (context-dependant)
NLGI	National Lubricating Grease Institute
ODS	Off-driller's side
OEM	Original equipment manufacturer
OSHA	Occupational Safety and Health Administration
OD	Outside diameter
PLC	Programmable Logic Controller
PPE	Personal Protective Equipment
PSI	Pounds per square inch (pressure)
RH	Right-hand
VAC	Volts, alternating current
VDC	Volts, direct current

1.3.2 Terms and Definitions

TERM	DEFINITION
ATEX-certified	Conforms with the EU "ATEX" directive for equipment operated within an explosive atmosphere.
Backup	The component of a tong-backup arrangement that mechanically attaches to the stationary side of a tubular connection and provides resistance to the tong when making up or breaking out a joint.
Box	The female side of a pipe connection
Break Out	Loosening, unthreading, and disconnecting a connection (typically a tubular connection). The term may also apply to a general threaded connection.
CE-marked	CE compliant. Conforms with the essential requirements of the applicable Conformité Européenne directives.
Clamp	To grasp the stationary side of a pipe joint with a backup.
Die	A component of a jaw die kit that provides the mechanical contact between the tong and the tubular.
Joint	Also called a "pipe joint". A threaded tubular connection.
Load Cell	A hydraulic device that transmits a proportional signal to a torque gauge for the purpose of measuring connection torque.
Make Up	Threading together a connection (typically a tubular connection) and tightening to a specified torque. The term may also apply to a general threaded connection.
Pin	The male side of a pipe connection
Ring Gear	The rotating component, mechanically coupled to a hydraulic motor through a gear train, which provides rotation to the pin-side of a tubular connection through the use of jaw assemblies
Safety Door	A device mechanically connected to the door of a hydraulic power tong that uses hydraulic switching to prevent rotation of the cage plates when the tong door is open.
Sling	A rigid or non-rigid device used to hoist a piece of equipment using a crane.
Tank	Hydraulic fluid reservoir
Tong	The component of a tong-backup arrangement that mechanically attaches to the pin side of a tubular connection, and rotates the pin to make up or break out a connection
Un-clamp	To release the stationary side of a pipe joint with a backup.
WINCATT®	Data acquisition and torque/turns management system manufactured by McCoy Global



SECTION 2: EQUIPMENT DESCRIPTION & SPECIFICATIONS



**This page intentionally
left blank**

2.0 EQUIPMENT DESCRIPTION

This technical manual applies to all standard and explosion-proof models of this equipment using WINCATT® 7 software

McCoy Global's WINCATT® torque & turns monitoring system combines software with external control hardware to provide real-time monitoring and control of tubular connections using hydraulic equipment, allowing easy customer specification of make-up parameters, make-up process control, and evaluation of connection quality.

A junction box serves as an interface between the tubular connection equipment and the WINCATT® system, providing several functions:

- conversion of hydraulic pressure output from load cell to an electronic signal (hydraulic load cells)
- conditioning of electronic signals (electronic load cells, turn counter encoder)
- amplification of outputs from the WINCATT® to the tubular connection equipment

The WINCATT® system outputs an electronic signal to a solenoid located on the connection equipment when pre-programmed values are met, actuating a valve that relieves hydraulic pressure on the connection equipment. The speed at which the system pressure is “dumped” allows precise control of the make-up torque applied to a tubular connection.

The WINCATT® system monitors an electronic signal from an encoder mounted on the connection equipment, allowing real-time tracking of the rotation speed of the equipment, and the number of turns required for making up a tubular connection. The system allows control of the rotational speed during the connection process.



Illustration 2.0.1: Standard WINCATT®



Illustration 2.0.2: ATEX WINCATT®

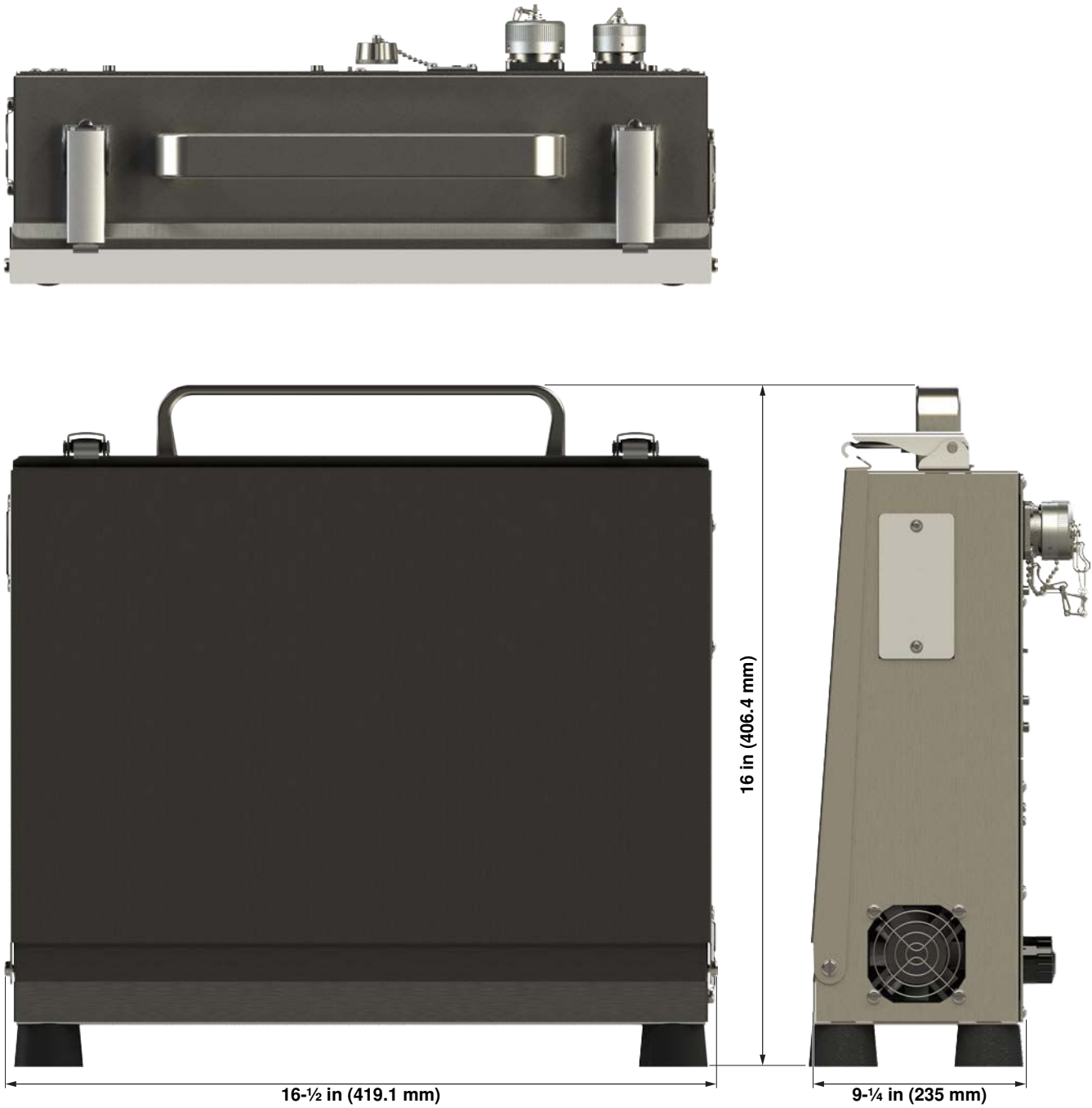

Illustration 2.0.3: WINCATT® Enclosure (Standard)

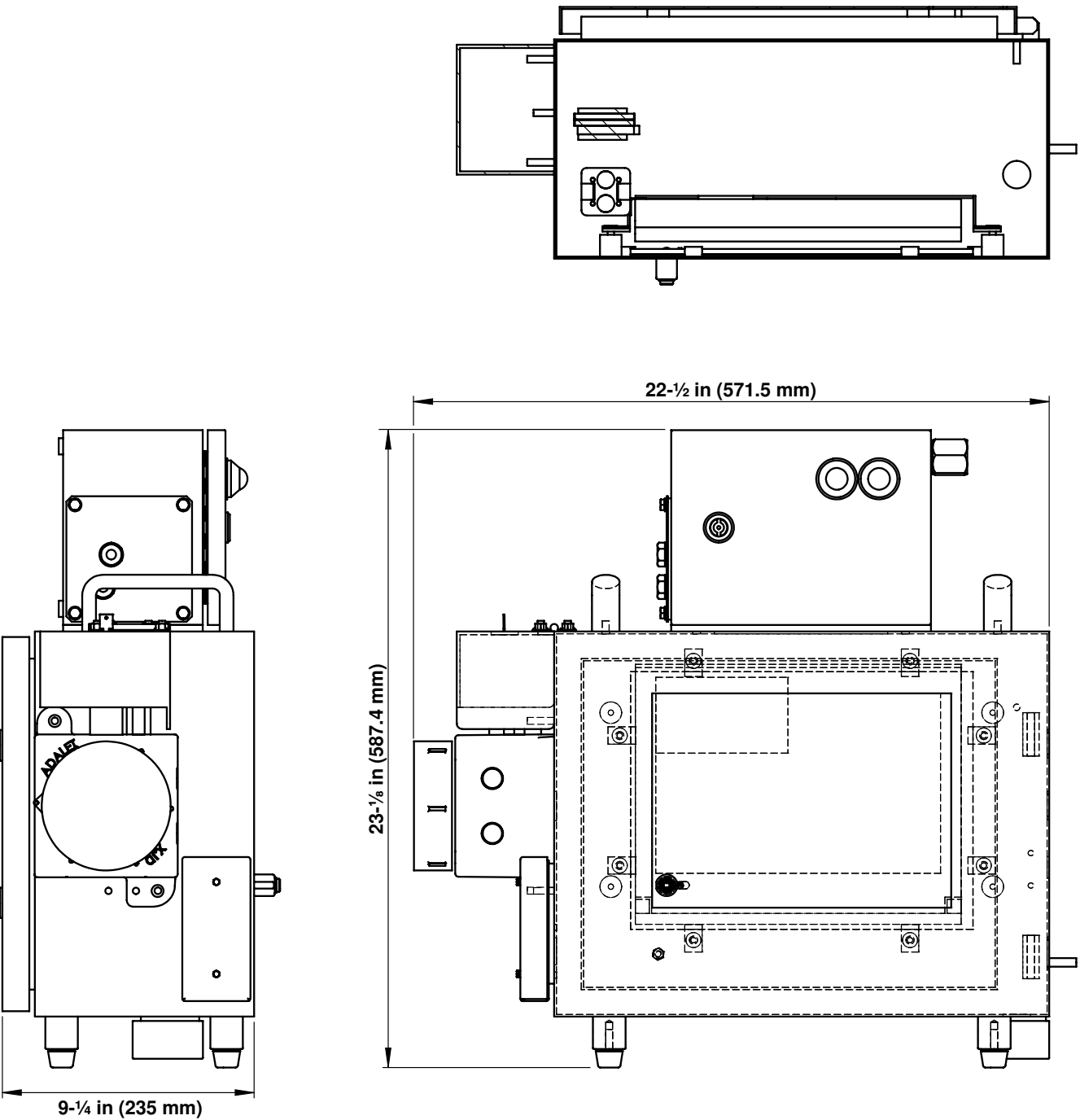

Illustration 2.0.4: WINCATT® Ex Enclosure

2.1 COMPONENT IDENTIFICATION

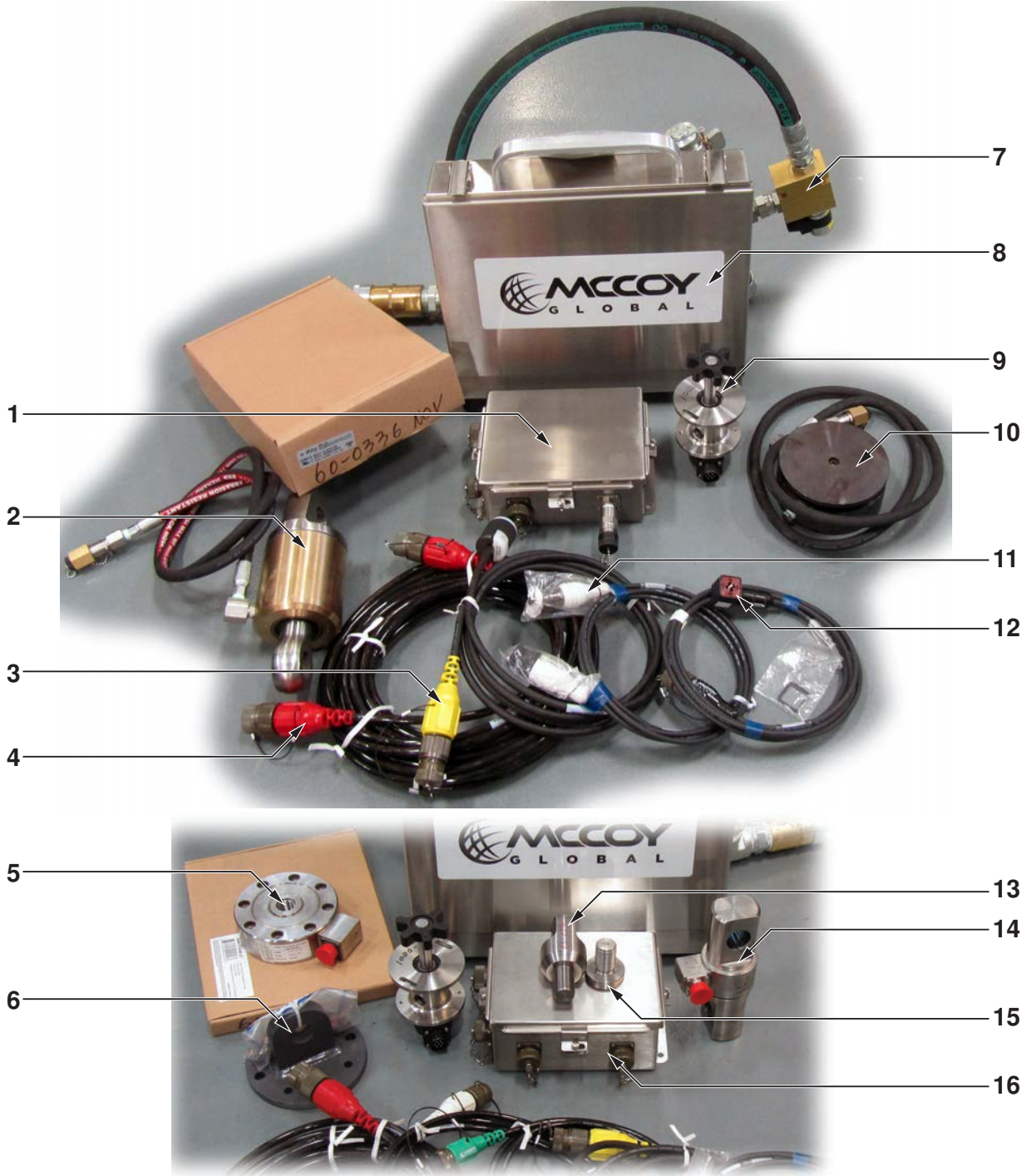

Illustration 2.1.1: WINCATT® Component Identification 01

Item	Description
1	Junction box (hydraulic)
2	Tension load cell (hydraulic)
3	Power cable (yellow connectors)
4	CT cable (red connectors)
5	Compression load cell (electronic)

2.1 COMPONENT IDENTIFICATION (CONT'D):



Illustration 2.1.2: WINCATT® Component Identification 02

Item	Description
6	Conversion plate, compression load cell to tension load cell (electronic)
7	Dump valve with hydraulic adapters
8	Standard WINCATT® (shown with protective panel locked in place)
9	Turns counter with encoder mount
10	Compression load cell (hydraulic)
11	Encoder cable (white connectors)
12	Dump valve cable (black connectors)
13	Eye fitting, compression load cell to tension load cell conversion (electronic)
14	Tension load cell (electronic)
15	Button for compression load cell (electronic)
16	Junction box (electronic load cell)
17	Dump valve cable w/ dump valve assembly (ATEX version)
18	Power cable (ATEX version)
19	WINCATT® Ex (ATEX version)
20	Air filtration assembly (ATEX version)
21	Grounding clamp (ATEX version)
22	Dump valve cable (ATEX version)
23	Power connection (ATEX version)

2.1 COMPONENT IDENTIFICATION (CONT'D):

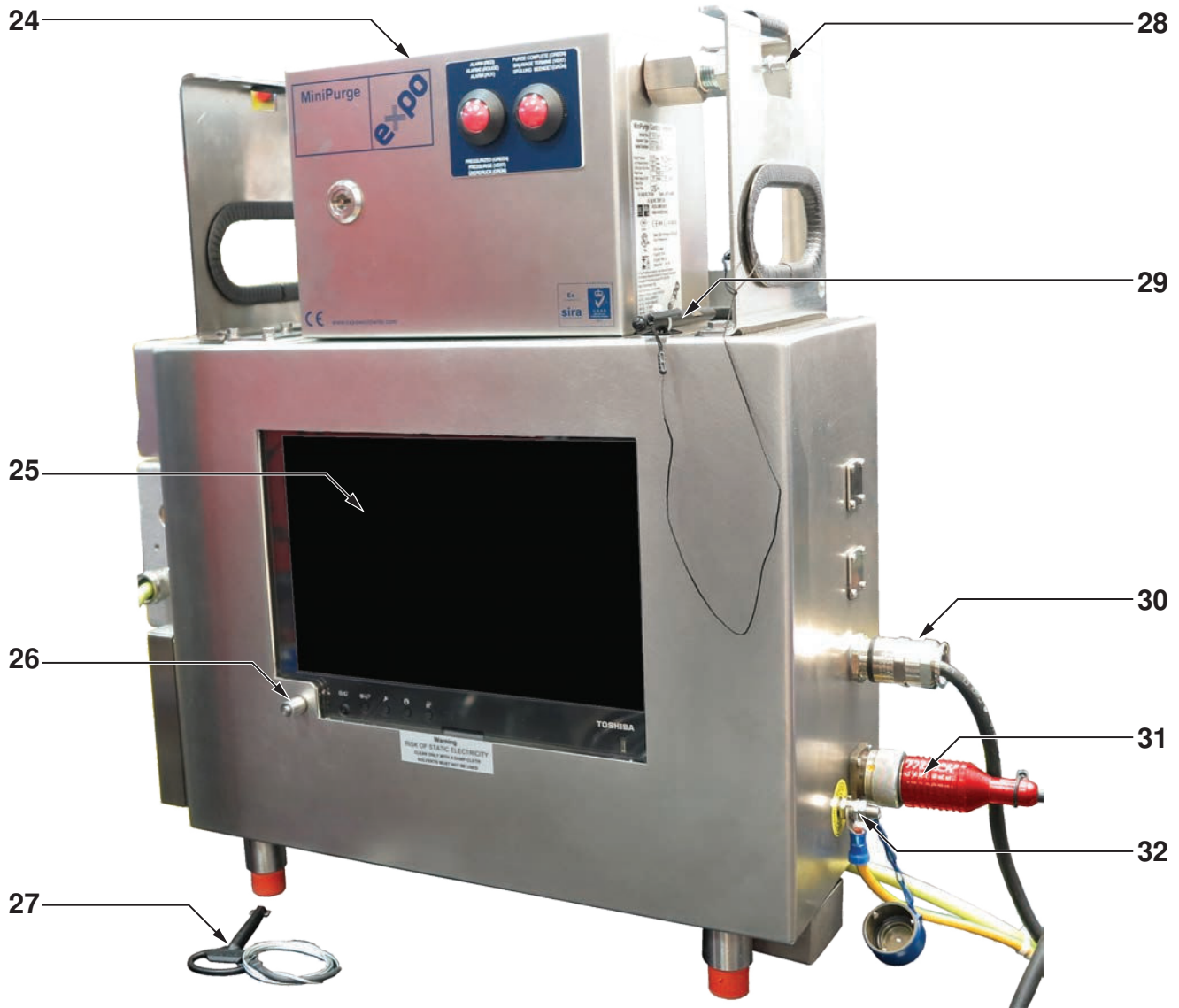

Illustration 2.1.3: WINCATT® Component Identification 03

Item	Description
24	MiniPurge controller (ATEX version only)
25	Tablet computer
26	Power switch
27	Enclosure cam-lock key
28	Purge air quick-connect inlet (ATEX version only)
29	Tablet computer stylus
30	Dump valve cable connection (hard-wired)
31	CT cable connection
32	Ground connection

2.1 COMPONENT IDENTIFICATION (CONT'D):



Illustration 2.1.4: WINCATT® Component Identification 03

Item	Description
33	Purge system pressurized output
34	Pressure switch automatic / override switch
35	Pressure switch
36	MIU explosion-proof electrical junction box
37	MiniPurge system relief valve

2.1 COMPONENT IDENTIFICATION (CONT'D):



Illustration 2.1.4: WINCATT® Component Identification 04

Item	Description
38	Air supply regulator (set to 100 psi max pressure)
39	Water separator filter head
40	Water separator filter canister
41	Oil coalescing filter head
42	Oil coalescing filter canister

2.2 EQUIPMENT SPECIFICATIONS

Computer	Laptop computer running Windows operating system
Enclosure	Stainless steel (standard)
	Pressurized stainless steel type PE2E266 (ATEX)
Length	16-½ in / 419.1 mm (standard model)
	22-½ in / 571.5 mm (ATEX model)
Width	5 in / 127 mm (standard model)
	9-¼ in / 235 mm (ATEX model)
Height	16 in / 406.4 mm (standard model)
	23-½ in / 587.4 mm (ATEX model)
Sampling frequency	1 Hz to 8,000 Hz (user-defined)
Electronic system response time	less than 0.5 ms
Dump valve response time	10 to 30 ms
Final torque measurement	Average = optimum torque ±1 percent
Torque measurement accuracy	1 percent
Turns measurement accuracy	± 1 pulse (generated by turns counter)
Pressure accuracy	less than 1 percent



DANGER

DO NOT MODIFY OR ALTER ANY COMPONENT OR ASSEMBLY ON THIS TOOL.

IMPORTANT COMPUTER INFORMATION

The WinCatt computer is shipped with a clean, tested version of the Windows operating system. McCoy Corporation accepts no responsibility or liability for corruption of the operating system or factory-loaded software due to computer viruses, other destructive software, or any other file type downloaded from the Internet or any other external source.

McCoy accepts no responsibility or liability for corruption of the operating system or factory-loaded software due to installation of aftermarket software.



**This page intentionally
left blank**



SECTION 3: INSTALLATION AND COMMISSIONING



**This page intentionally
left blank**

Adequate setup and proper connections are essential in ensuring reliable operation of your McCoy equipment. For best results and long term reliability, read and obey the installation and commissioning instructions in this section.

3.0 RECEIPT, INSPECTION, AND HANDLING OF EQUIPMENT

⚠ CAUTION

YOUR EQUIPMENT HAS BEEN THOROUGHLY TESTED AND INSPECTED AT THE FACTORY. HOWEVER, MCCOY GLOBAL ADVISES INSPECTING YOUR EQUIPMENT FOR SHIPPING DAMAGE UPON RECEIPT, AND TESTING YOUR EQUIPMENT BEFORE RELEASING TO AN OPERATIONAL ENVIRONMENT.

Upon receipt inspect packaging materials for shipping damage. Shipping damage may include (but not be limited to) perforation of a crate, misshapen crate, crushed corners, missing hardware, scraped or bent metal, and impact or orientation indicators (like a "tip'n'tell). Record all shipping damage on the shipping manifest and ensure shipping company and McCoy are immediately contacted.

Remove all protective shipping materials including plastic wrap, desiccant packs, padding, etc and perform a visual inspection of the equipment. Check components for bending or buckling indicative of vertical impact. Immediately identify any shipping damage to the shipping company, and correct all damage before connecting equipment to a power source.

Perform an inventory of the received components and compare with the bill(s) of lading and the packing lists. Contact McCoy Global immediately if you have not received the

3.1 EQUIPMENT INSTALLATION AND CONNECTION

3.1.1 Standard WINCATT® System Installation

Please refer to the illustrations in sub-section 2.1 to identify components referenced during these instructions.

1. Disable hydraulic power to the equipment on which the new WINCATT® system will be installed.
2. Disconnect the main hydraulic feed and return lines from the equipment.
3. Install the dump valve:
 - a. Remove the protective caps from the hydraulic connections on the dump valve plumbing.
 - b. Connect the 1" hydraulic fitting on the dump valve plumbing to the hydraulic inlet, and connect the 1-1/4" hydraulic fitting on the dump valve plumbing to the discharge. The differing sizes of the connections ensures that the connections cannot be accidentally interchanged.
 - c. Connect the main hydraulic feed and supply lines to the dump valve plumbing.

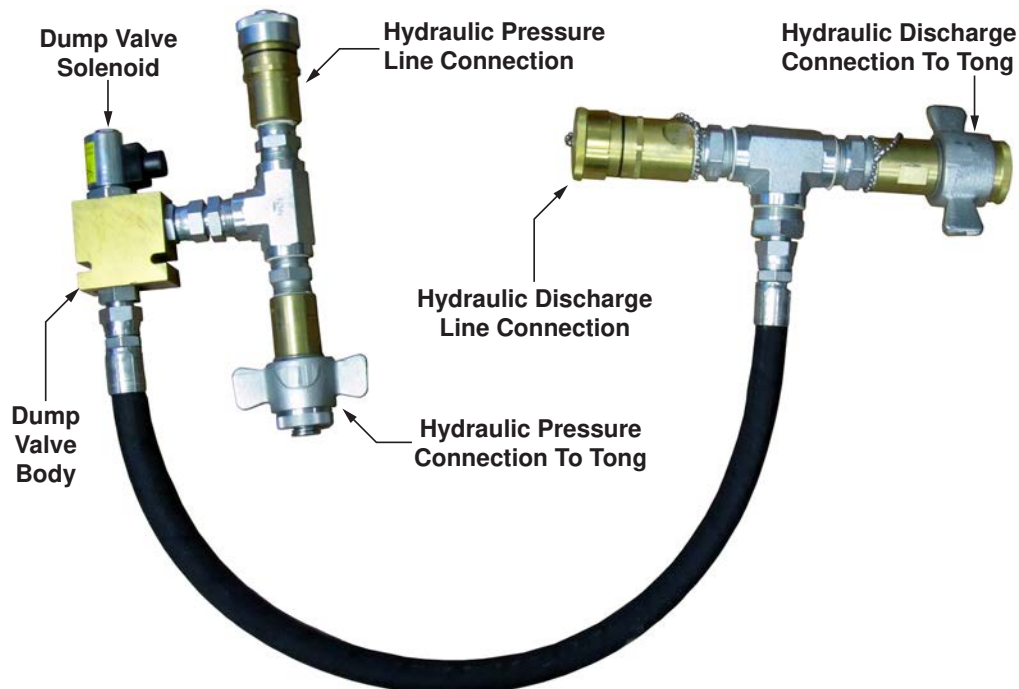

Illustration 3.1.1: Dump Valve Installation

3.1.1 Standard WINCATT® System Installation (Continued):

4. McCoy Global recommends mounting the turns counter encoder on the encoder mount before installing the mount on the tong. Typically McCoy Global ships a WINCATT® system with the encoder pre-mounted on the encoder mount. However, in some cases mounting the encoder at a customer site may be required. Follow these steps to mount the encoder:
 - a. McCoy Global recommends rotating the shaft of the encoder mount so one of the set screws in the spring coupler align with the flat on the encoder shaft (see illustration 3.1.2). Use an Allen wrench to tighten the set screw until it contacts the flat, but do not completely tighten.

In some cases the coupling may require disconnection from the shaft within the mount before attaching to the encoder shaft. Once the coupling is securely attached to the encoder shaft, re-attach to the shaft in the mount.

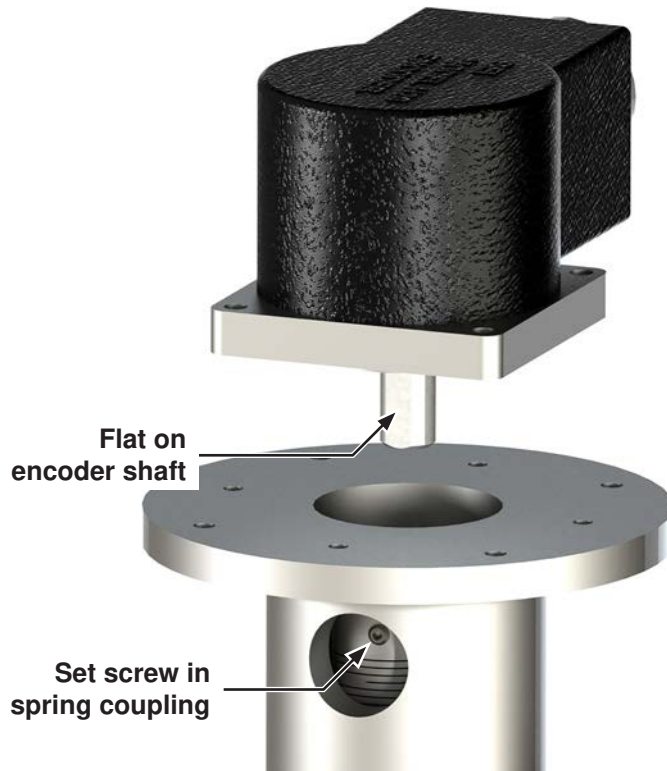

Illustration 3.1.2: Mounting Encoder To Encoder Mount

- b. Secure the encoder to the encoder mount using four #6-32 x 1/2" hex socket head machine screws. Tighten only finger-tight.
 - c. Use an Allen wrench to tighten the two set screws in the spring coupler against the encoder shaft (rotate the encoder mount shaft to expose the second set screw). Use caution not to over-tighten the set screws.
 - d. Use an Allen wrench to tighten the machine screws securing the encoder to the encoder mount.
5. Install the turns counter encoder and encoder mount:

Type 1 Installations - Equipment Using Encoder Mount Assembly 60-0001/A/B

- a. Locate the cover plate on the top plate of the tong (see illustration 3.1.3).

3.1.1 Standard WINCATT® System Installation (Continued):

5. Install the turns counter encoder and encoder mount (continued):

**Illustration 3.1.3: 60-0001 Encoder Mount Installation Location**

- b. Scribe or cut the paint seam between the cover plate and the top plate. Prying the cover plate from the top plate without scribing or cutting the paint seam risks flaking paint from the top plate, exposing the metal to air and introducing rust and corrosion.
- c. Remove the two 1/4" bolts fastening the cover plate to the top plate, and remove the cover plate. Use care that the paint coating does not flake from the top plate in the vicinity of the encoder mount mounting hole.

Type 2 Installations - Equipment Using Encoder Mount Assembly 55142:

- a. Locate the cover plate on the bearing cap for the secondary gear assembly cap, located on the top plate of the tong near the motor. The following illustration shows a typical installation, but note that the location may vary between equipment.

**Illustration 3.1.4: Encoder Mount Installation Location**

3.1.1 Standard WINCATT® System Installation (Continued):

5. Install the turns counter encoder and encoder mount (continued):
 - b. Scribe or cut the paint seam between the cover plate and the bearing cap. Prying the cover plate from the top plate without scribing or cutting the paint seam risks flaking paint from the bearing cap, exposing the metal to air and introducing rust and corrosion.
 - c. Mount the encoder mounting plate to the bearing cap using two $\frac{3}{8}$ " UNC x $\frac{3}{4}$ " hex socket head cap screws.
 - d. Mount the encoder coupling to the encoder using a #10-32 x $\frac{1}{4}$ " hex socket head set screw. McCoy Global recommends aligning the flat on the encoder shaft with the set screw. Tighten the set screw with an Allen wrench.
 - e. Mount the encoder to the mounting plate using four #6-32 x $\frac{1}{2}$ " machine screws, ensuring the tab on the coupling is correctly mated with the top of the secondary gear shaft.
6. Locate a suitable installation location for the junction box. McCoy Global recommends installing the junction box on or near the equipment in use, in a location in which the electrical cables and hydraulic pressure line from the load cell will not become stressed or tangled during equipment operation. The standard installation includes a 60 in (1.524 m) hydraulic line between the load cell and junction box, but an optional 120 in (3.048 m) hydraulic line is optional. **NOTE:** The WINCATT® system is calibrated with whichever hydraulic load cell line shipped with the system. Changing the length of the hydraulic pressure line between the load cell and junction box will void the calibration and result in inaccurate torque measurement.

NOTICE

WINCATT® IS CALIBRATED FOR THE HYDRAULIC LOAD CELL HOSE SHIPPED WITH THE SYSTEM. CHANGING THE HOSE LENGTH BETWEEN THE LOAD CELL AND JUNCTION BOX VOIDS THE CALIBRATION.

7. Locate a suitable installation location for the WINCATT® computer enclosure. The maximum distance between the computer enclosure and the junction box is determined by the length of the CT cable supplied. A standard WINCATT® system is shipped with a 50 ft (15.25 m) CT cable. McCoy Global recommends placing the enclosure in a position that allows adequate maneuvering of the tubular connection equipment without placing stress on the CT cable.
8. Connect the junction box to the load cell, dump valve, turns counter encoder, and the WINCATT® computer enclosure:
 - Remove the protective caps from the ends of the encoder cable (white connectors). Connect the male end of the cable to the appropriate receptacle on the junction box (see illustration 3.1.5). Connect the female end to the connection on the encoder.
 - Remove the protective cap from the male end of the dump valve cable (black connector) and connect to the appropriate receptacle on the junction box (see illustration 3.1.5). Remove the protective tape from around the rectangular dump valve actuator, taking care that the retaining screw is not lost in the process. Remove the rectangular rubber gasket from the bag attached to the cable. Place the gasket between the actuator and the dump valve and use the retaining screw to fasten the actuator to the dump valve solenoid.
 - Remove the protective caps from the ends of the CT cable (red connectors). Connect the male end of the CT cable to the appropriate receptacle on the junction box (see illustration 3.1.5).
 - **HYDRAULIC LOAD CELL CONNECTION:**

Remove the protective cap on the load cell hydraulic quick-connect fitting and connect to the receptacle on the junction box. Tighten hand-tight only - do not use mechanical means to tighten. Ensure the fitting is completely made up.

3.1.1 Standard WINCATT® System Installation (Continued):

8. Connect the junction box to the equipment (continued):

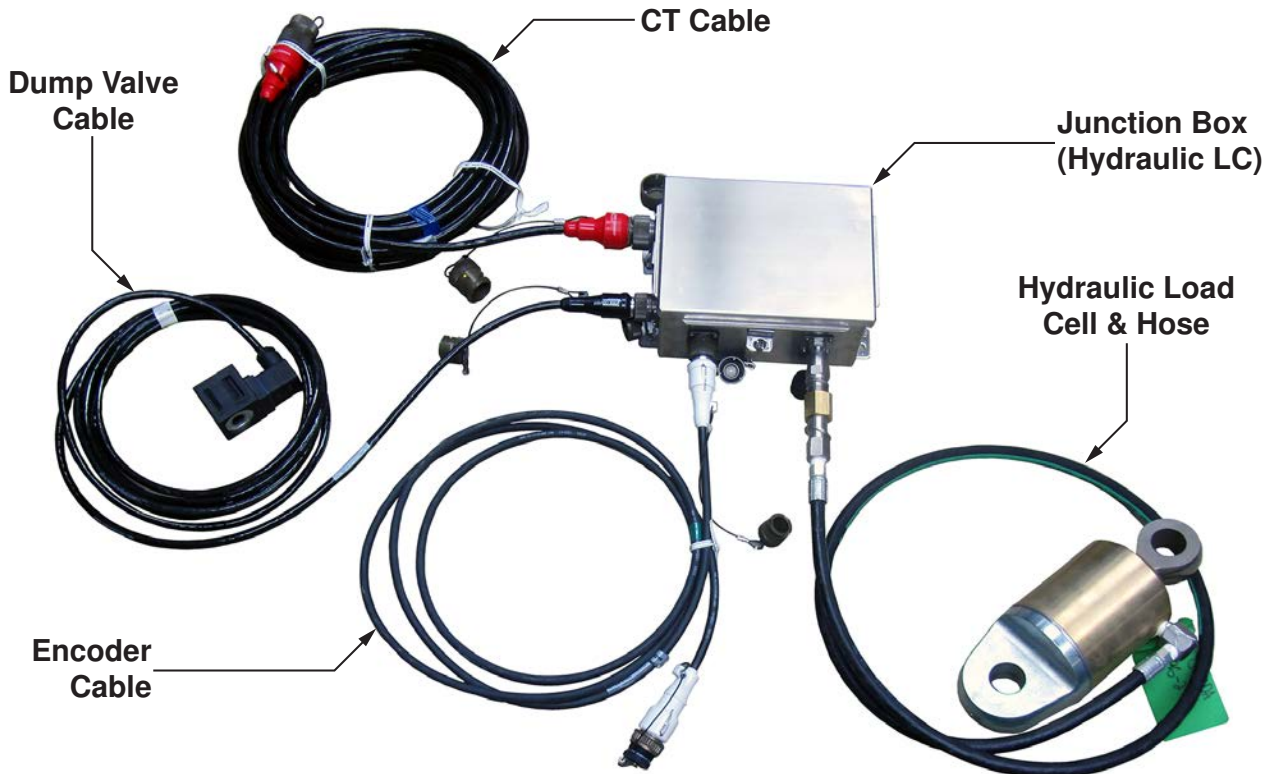

Illustration 3.1.5: Standard Junction Box Connection (Hydraulic Load Cell)

• **ELECTRONIC LOAD CELL CONNECTION**

Remove the protective caps from the ends of the encoder cable (green connectors). Connect the male end of the cable to the appropriate receptacle on the junction box (see illustration 3.1.6). Connect the female end to the connection on the electronic dump valve.

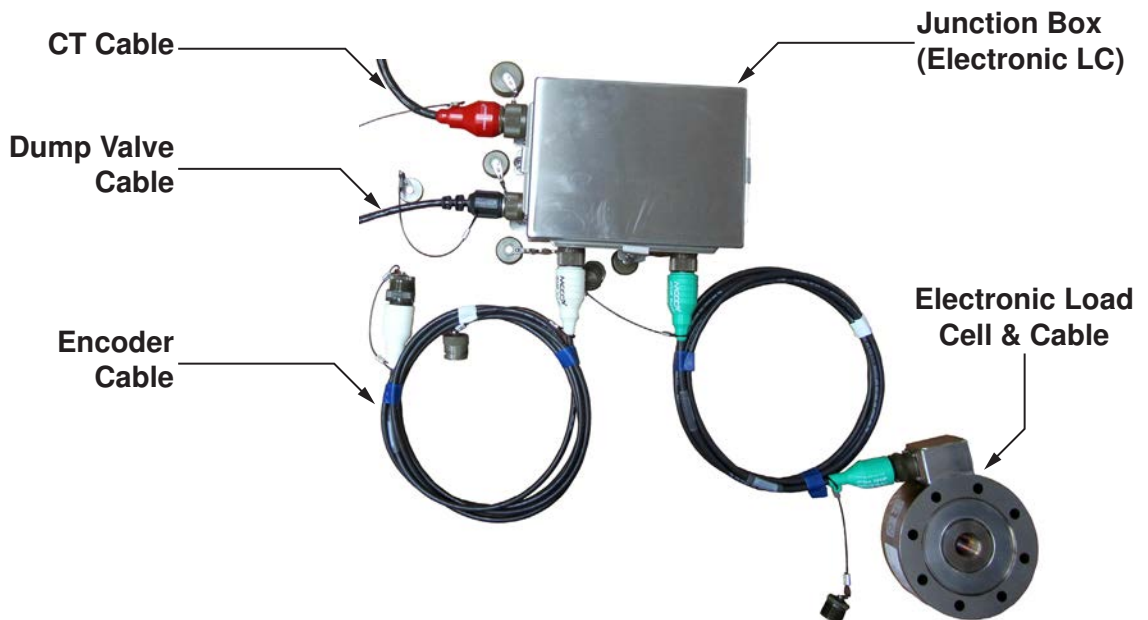

Illustration 3.1.6: Standard Junction Box Connection (Electronic Load Cell)

3.1.1 Standard WINCATT® System Installation (Continued):

9. Connect the female end of the CT cable to the proper bulkhead connector on the WINCATT® computer enclosure. Connect the power supply connector to the proper bulkhead connector on the WINCATT® computer enclosure (see illustration 3.1.7).



Illustration 3.1.7: Standard Junction Box Connection (Electronic Load Cell)

3.1.2 WINCATT® Ex System Installation

Please refer to the illustrations in sub-section 2.1 to identify components referenced during these instructions.

1. Disable hydraulic power to the equipment on which the new WINCATT® system will be installed.
2. Disconnect the main hydraulic feed and return lines from the equipment.
3. Install the dump valve (see sub-section 3.1.1, step 3). NOTE: The dump valve cable for the WINCATT® Ex system is shipped as a sub-component of the dump valve assembly. The coil is already connected to the dump valve body.
4. If not already done, install the turns counter encoder on the encoder mount (see sub-section 3.1.1, step 4).
5. Install the encoder and encoder mount on the equipment (see subsection 3.1.1, step 5).
6. Install the junction box (see subsection 3.1.1, step 6).
7. Locate a suitable installation location for the WINCATT® Ex computer enclosure. The standard 50 ft (15.25 m) length of the CT cable determines the maximum distance between the computer enclosure and the junction box. McCoy Global recommends placing the enclosure in a position that allows adequate maneuvering of the tubular connection equipment without placing stress on the CT cable.

3.1.2 WINCATT® Ex System Installation (Continued):

9. Connect the turns counter encoder and the hydraulic load cell to the junction box:
 - Remove the protective caps from the ends of the encoder cable (white connectors). Connect the male end of the cable to the appropriate receptacle on the junction box (see illustration 3.1.8). Connect the female end to the connection on the encoder.

! DANGER

JUNCTION BOXES PROVIDED WITH THE WINCATT® EX SYSTEM ARE PURPOSE-BUILT FOR EXPLOSIVE ATMOSPHERES. ONLY USE THE APPROVED JUNCTION BOX (PN 60-0423)

- Remove the protective cap on the load cell hydraulic quick-connect fitting and connect to the receptacle on the junction box. Tighten hand-tight only - do not use mechanical means to tighten. Ensure the fitting is completely made up.

Only use hydraulic load cells with a WINCATT® Ex system. Using an electronic load cell in an explosive environment presents an immediate hazard.

! DANGER

DO NOT USE ELECTRONIC LOAD CELLS WITH A WINCATT® EX SYSTEM



Illustration 3.1.8: WINCATT® Ex Junction Box Connections

3.1.2 WINCATT® Ex System Installation (Continued):

10. Remove the protective caps from the male end of the CT cable (red connectors), and connect to the appropriate receptacle on the junction box (see illustration 3.1.8).
11. Remove the protective caps from the female end of the CT cable (red connectors), and connect to the appropriate receptacle on the WINCATT® Ex computer enclosure (see illustration 3.1.9).

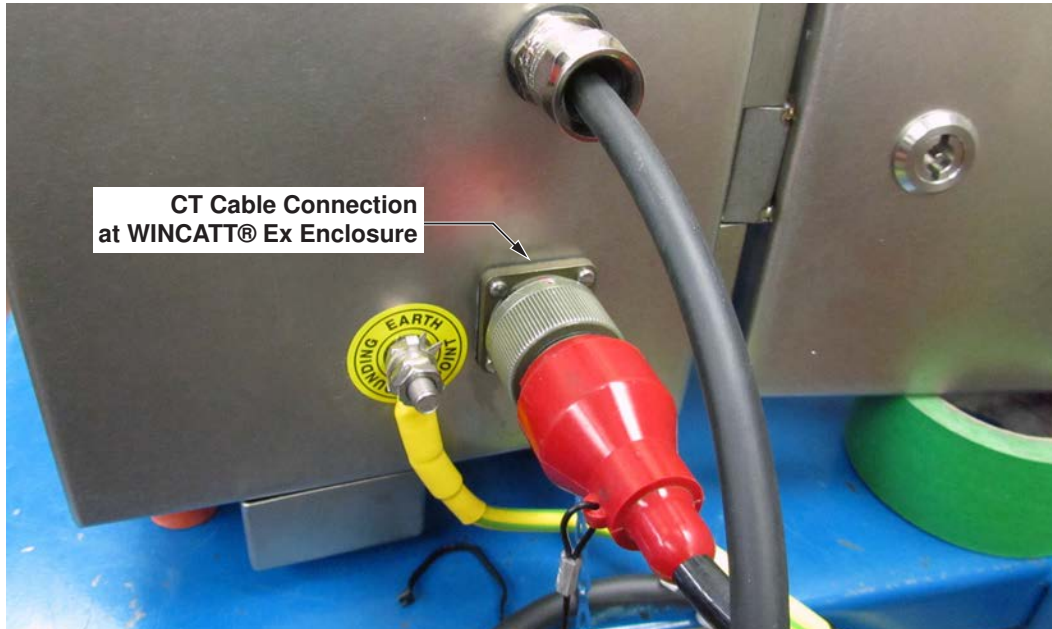

Illustration 3.1.9: CT Cable Connection At WINCATT® Ex Enclosure

12. Use the supplied grounding clamp (see illustration 3.1.10) to establish an earth ground to the WINCATT® Ex computer enclosure. The ground clamp must be attached to bare metal which is in direct contact with an earth ground.

⚠ WARNING

CONNECT THE GROUNDING CLAMP TO BARE METAL IN DIRECT CONTACT WITH AN EARTH GROUND

13. Connect the locking ATEX-approved connector on the dump valve cable to its mate on the dump valve pigtail attached to the WINCATT® Ex computer enclosure (see illustration 3.1.10). Fully engage the locking mechanism.
14. Connect the locking ATEX-approved connector on the power cable to its mate on the power pigtail attached to the WINCATT® Ex computer enclosure (see illustration 3.1.10). Fully engage the locking mechanism.

3.1.2 WINCATT® Ex System Installation (Continued):



Illustration 3.1.10: Cable Pigtail Connections At WINCATT® Ex Enclosure

15. Connect the supply side of the air filtration unit to a standard 80 psi (550 kPa) clean, dry air supply (see illustration 3.1.11). Connect the discharge side of the air filtration assembly to the quick-connect on the WINCATT® Mini-Purge unit (see illustration 3.1.12). McCoy Global has preset the regulator on the filter assembly and the pressure switch within the WINCATT® Mini-Purge unit to satisfy all purge requirements. McCoy Global recommends a minimum internal diameter of at least 3/8 in (9.5 mm) for all air lines to ensure adequate air flow.



Illustration 3.1.11: WINCATT® Ex Purge Air Filter Assembly

NOTICE

AIR SUPPLY PRESSURE LESS THAN 80 PSI (550 KPA) MAY NOT SUFFICIENTLY SATISFY AIR PURGE AIR INTERLOCK REQUIREMENTS.

3.1.2 WINCATT® Ex System Installation (Continued):



Illustration 3.1.11: Purge Air Connection - MiniPurge Controller

3.2 WINCATT® SYSTEM INITIALIZATION

The instructions in this subsection describe applying power to standard WINCATT® and WINCATT® Ex systems, and creating a new job using the software. Following creation of a new job the hardware may be tested for proper operation using the system software.

3.2.1 Standard WINCATT® Start-up

1. Plug the power cable into a standard 110-230V AC electrical outlet. Non-ATEX certified units operating in Europe require an adapter to adapt the North American-style plug to a European-style plug.
2. Start your system. Applying AC to a standard WINCATT® automatically starts the computer. In the event that applying power does not automatically start the computer, start the computer manually by removing the panel on the side of the enclosure and depress the power button on the computer until it boots.

Remove this cover to access
power button on computer



Illustration 3.2.1: Power Button Access - Standard WINCATT® Enclosure

3. Once energized allow the computer to completely boot up, indicated by display of the standard Windows desktop interface screen.
4. Initialization is complete - go to sub-section 3.3.

3.2.2 WINCATT® Ex Start-up

1. Enable air pressure to the air filter assembly. Adequate air pressure satisfies the air pressure interlock (see illustration 3.2.2), turning the indicator from red to green.

NOTICE

AIR SUPPLY PRESSURE LESS THAN 80 PSI (550 KPA) MAY NOT BE SUFFICIENT TO SATISFY AIR PURGE AIR INTERLOCK REQUIREMENTS.

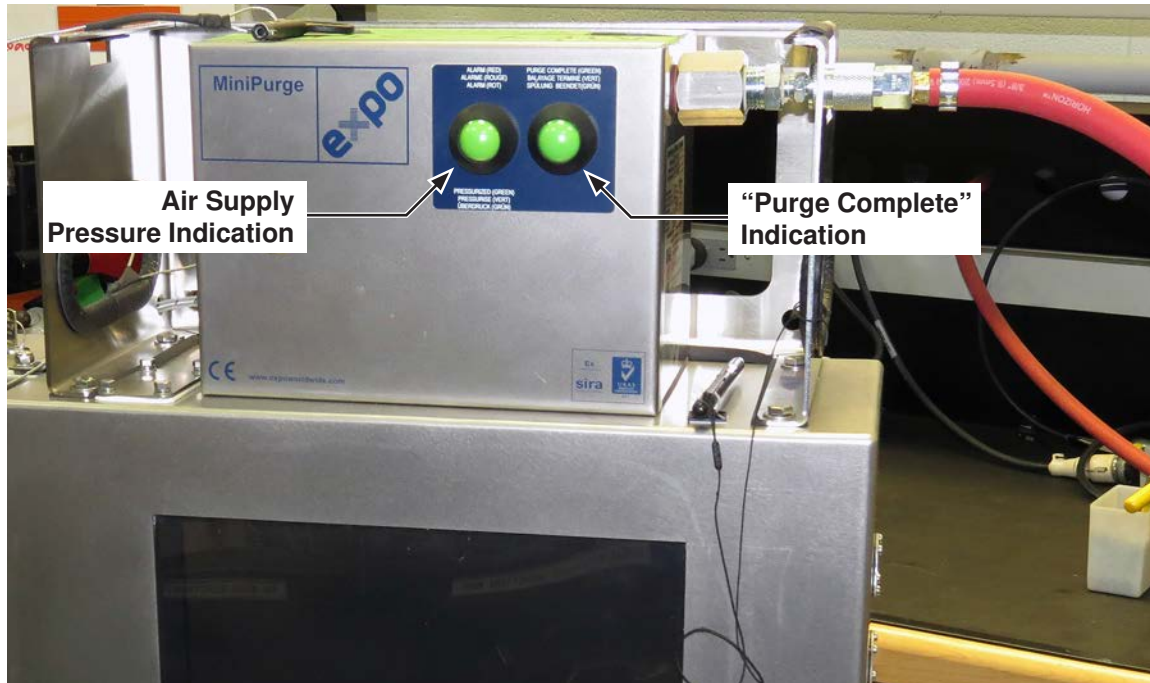

Illustration 3.2.2: MiniPurge Interlock Indicators

2. Allow the MiniPurge controller to complete the air purge cycle, which typically takes ten to twelve minutes. Upon completion of the purge cycle the “Purge Complete” indicator turns from red to green. **OPERATION NOTE: Power to the system computer and peripherals (with the exception of the MiniPurge Unit) is disabled until air pressure and purge cycle requirements are met.**
3. Depress the power button on the front of the enclosure, at the bottom left side of the computer screen (see illustration 2.1.3). Allow the system computer to completely boot up, indicated by display of the standard Windows desktop interface screen.



SECTION 4: PROGRAMMING & CONFIGURATION



**This page intentionally
left blank**

4.0 WINCATT® CONNECTION LIBRARY

1. Launch the WINCATT® software by using the stylus to double-clicking the WINCATT® 7 icon in the center of the display. Note that the standard WINCATT® system uses a touch-screen that may be operated using the tip of your finger. The program will display a splash screen while loading, followed by the WINCATT® 7 “home” screen.

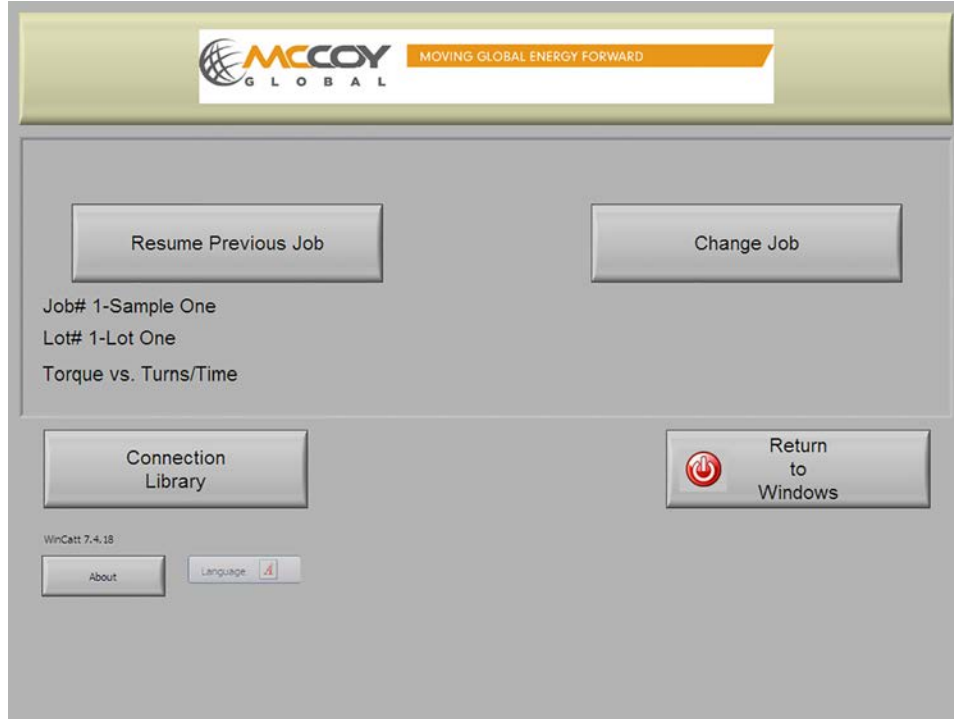

Illustration 4.0.1: WINCATT® 7 Home Screen

2. At least one recipe for a connection type must be programmed before system hardware may be tested and/or modified. Select “Connection Library” on the home screen to launch the Connection Library screen. **PROGRAMMING NOTE:** McCoy Global pre-programs a default connection (called Sample Type 01) in the Connection Library.

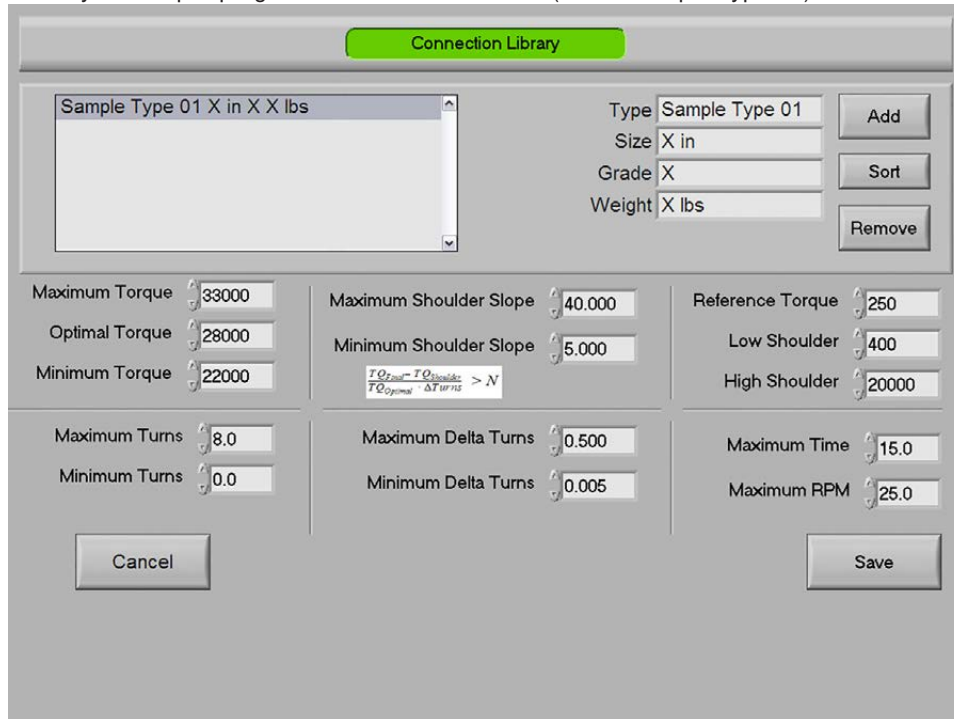

Illustration 4.0.2: WINCATT® 7 Connection Library Screen

4.0 WINCATT® CONNECTION LIBRARY (CONTINUED):

Options on the Connection Library screen include:

Add: add a new connection to the Connection Library

Sort: alphabetically sort the connections in the Library window (top left part of the screen)

Remove: remove a connection from the Connection Library

3. Select “Add” on the Connection Library screen to program a new connection. Enter the type of connection as well as the size, grade, and weight. The fields in the lower two-thirds of the Connection Library screen allow entry of parameters for the programmed connection, which are the conditions by which the WINCATT® software monitors and assess the connection.

Precautions to be observed while programming a connection:

- The value entered as “Maximum Shoulder Slope” must be higher than the value entered as “Minimum Shoulder Slope”.
- The value entered as “Maximum Delta Turns” must be higher than the value entered as “Minimum Delta Turns”.
- The value entered as “High Shoulder” must be higher than the value entered as “Low Shoulder”.
- The value entered as “Low Shoulder” must be higher than the value entered as “Reference Torque”.
- No “maximum” value can be set at 0.
- Do not use “N/A” as a value for any field.

Once all fields have been satisfactorily completed select “Save” to save the connection to the Connection Library and return to the WINCATT® 7 home screen.

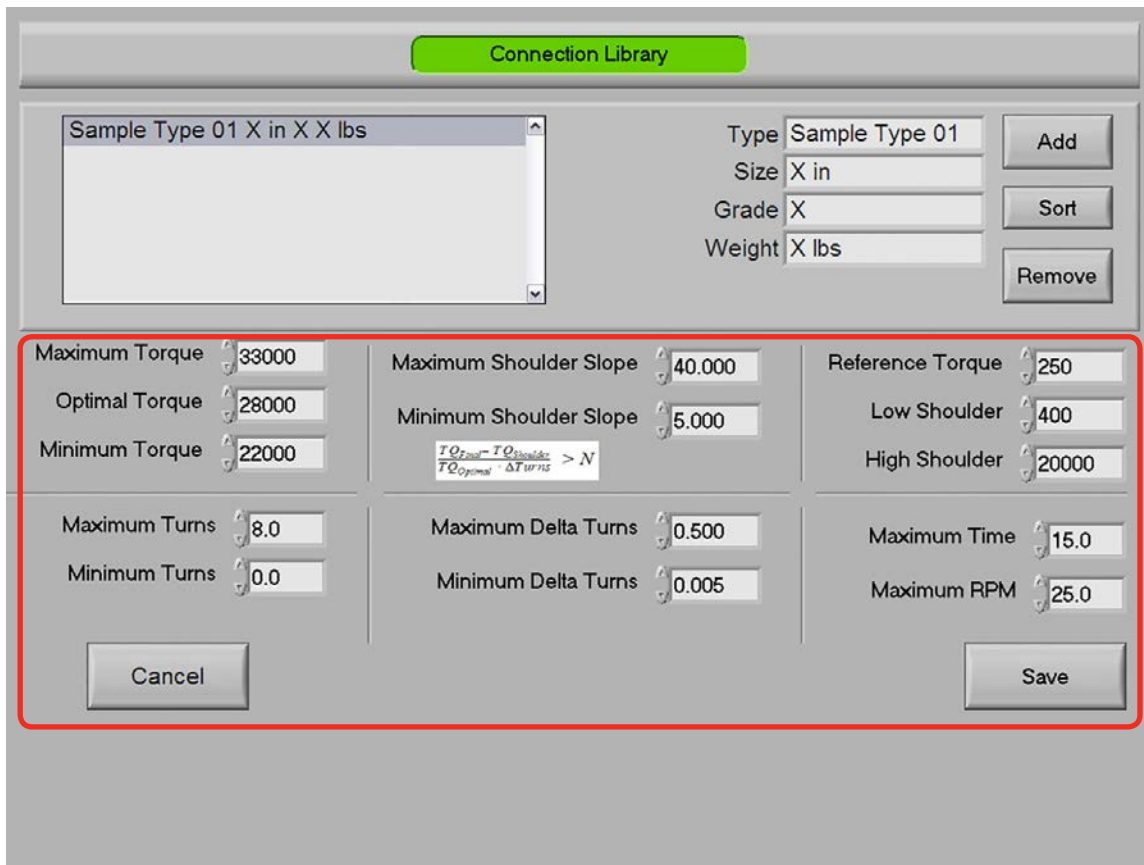

Illustration 4.0.3: WINCATT® 7 Connection Library Screen - Connection Parameters

4.1 PROGRAMMING A NEW WINCATT® JOB

1. Begin on the WINCATT® 7 home screen. Select “Change Job” to load the job menu.

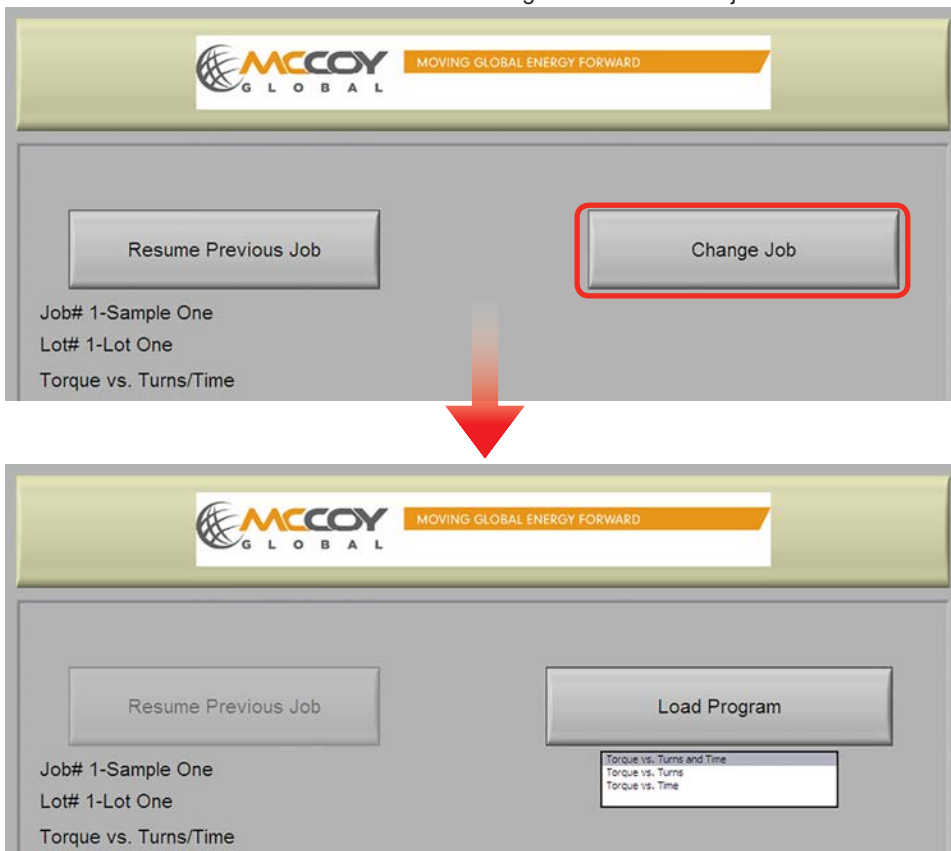

Illustration 4.1.1: Invoking Job Selection Menu on Home Screen

2. Select the preferred job type (Torque vs. Turns and Time, Torque vs. Turns, Torque vs. Time) from the displayed menu and select “Load Program” to launch the Job Management screen.

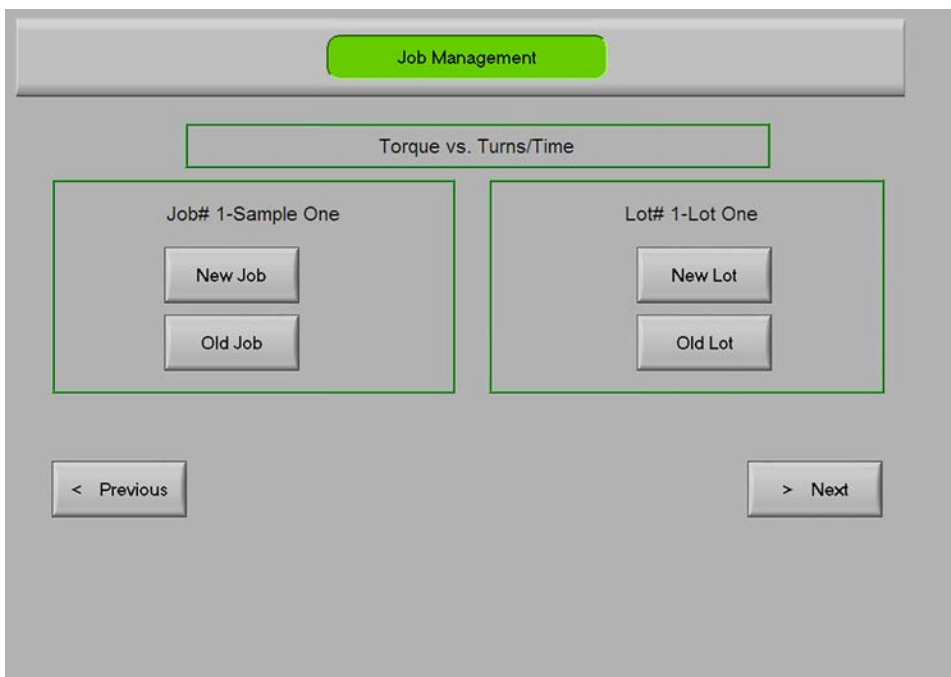

Illustration 4.1.2: Job Management Screen

4.1 PROGRAMMING A NEW WINCATT® JOB (CONTINUED):

Typically the Job Management screen lists the currently selected job and lots (seen as “Job# 1-Sample One” and “Lot# 1-Lot One” in illustration 4.2.2). However, upon initial programming the Job and Lot fields will be blank and the “Lot” selection (both) and “Old Job” buttons will be unavailable if no jobs or lots have previously been programmed.

3. Select “New Job” to launch the New Job & Lot screen to enter a new job name, at which time a new lot name may be entered as well.

PROGRAMMING NOTES:

Job and Lot names may not be changed after returning to the Job Management page. Ensure your job and lot have been satisfactorily names before selecting “OK” on the New Job & Lot page.

Do not end a job or lot name with a period or space. Doing so will cause program errors and may result in loss of programmed data.

NOTICE**DO NOT END A JOB NAME OR LOT NAME WITH A PERIOD OR SPACE**

Illustration 4.1.3: New Job & Lot Screen

Selecting “OK” saves the job name (and lot name, if applicable) and returns to the Job Management screen. Note that the job & lot names just programmed are now displayed.

4. Confirm that the desired job and lot are displayed, then select “Next” to advance to the Connection Type screen, where you may assign a connection type (previously programmed in the connection library) to the current job.

PROGRAMMING NOTES:

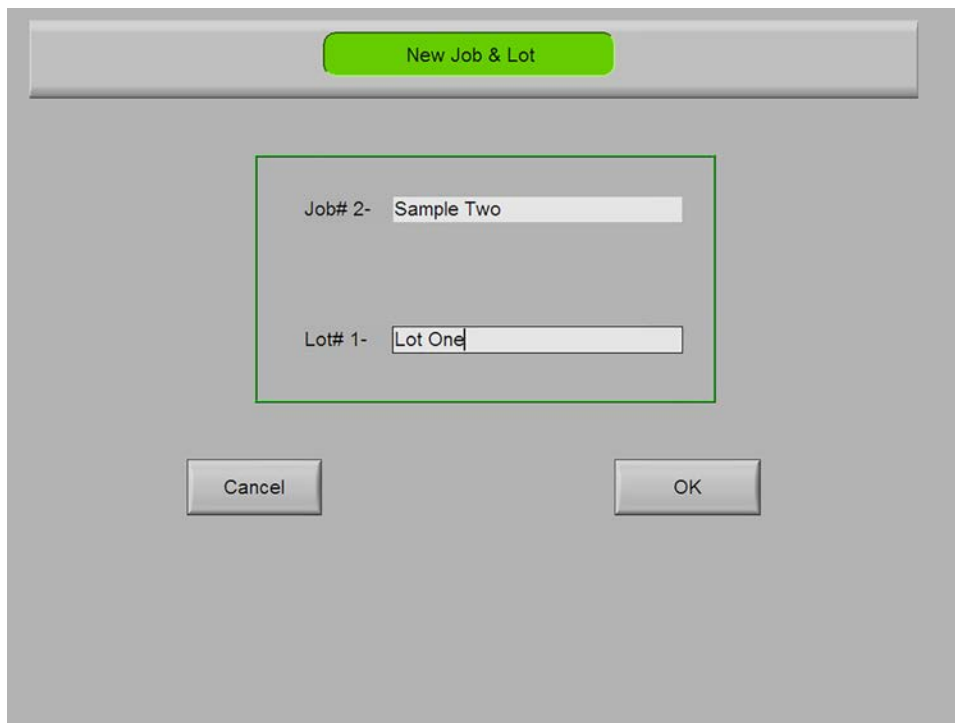
This is the only time a connection type may be assigned to a particular job. Selecting “Previous” on the Connection Type screen re-loads the Job Management screen and automatically loads the default programmed connection because a job cannot be created without assigning a connection type. Selecting “Next” on the Job Management screen after loading the default connection parameters will proceed directly to the Data Acquisition screen.

4.1 PROGRAMMING A NEW WINCATT® JOB (CONTINUED):

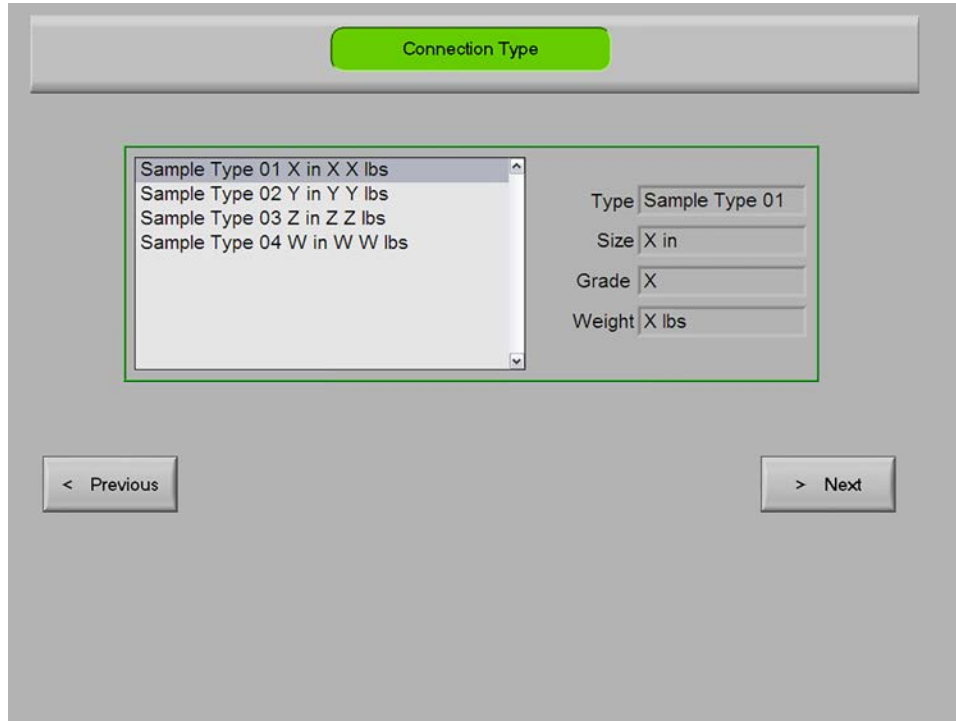

Illustration 4.1.4: Connection Type Screen

Select the desired connection from the displayed list on the Connection Type screen, then select “Next” to advance to the Program Settings screen. Selecting “Next” on the Connection Type screen without actively selecting a connection will load the parameters of the first connection in the library list.

5. Select “Next” on the Job Management screen to advance to the “Program Settings” page, allowing review of the parameters originally set in the Connection Library.

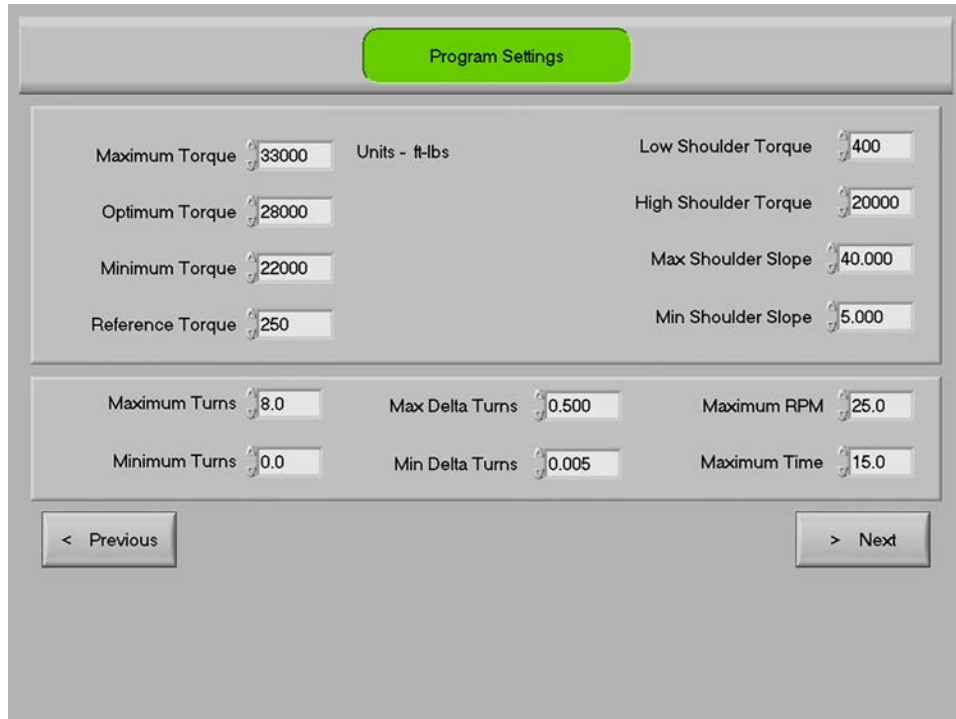

Illustration 4.1.5: Program Settings Screen

4.1 PROGRAMMING A NEW WINCATT® JOB (CONTINUED):

Review the displayed connection parameters. Note that parameters regarding shouldered connections are not available if “Torque versus Time” is selected as the job type. Select “Next” on the Program Settings page to advance to the Hardware screen.

Selecting “Next” on the Program Settings page following alteration of data in any field launches a pop-up confirmation window.

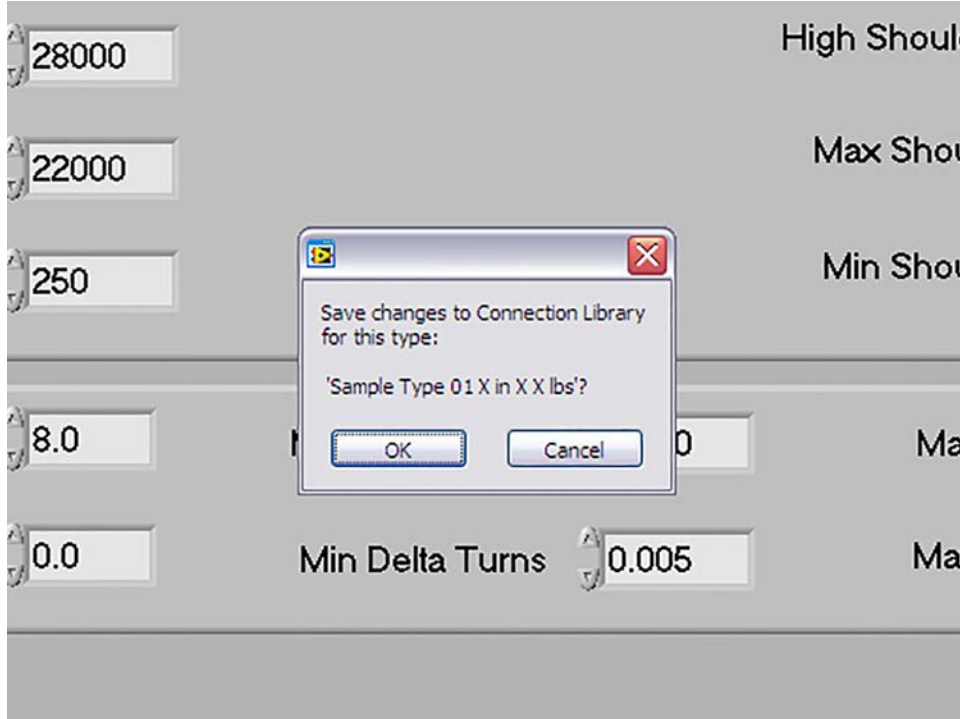

Illustration 4.1.5: Program Settings Screen

Select “OK” to overwrite and save the new parameters for the connection type in the Connection Library. Select “Cancel” to apply the changes to the current job only. The original parameters will remain intact in the Connection Library. Selection of either option closes the pop-up dialogue box and advances to the Hardware page.

4.2 HARDWARE TEST & CONFIGURATION

Progressing from the Program Settings screen invokes the Hardware screen. McCoy recommends reviewing all hardware parameters and to perform all available tests at the beginning of every job.

4.2.1 Selecting & Testing A Load Cell

1. Select "Torque Calibration" to launch the Load Cell Calibration screen. From this screen the load cell may be selected and tested.

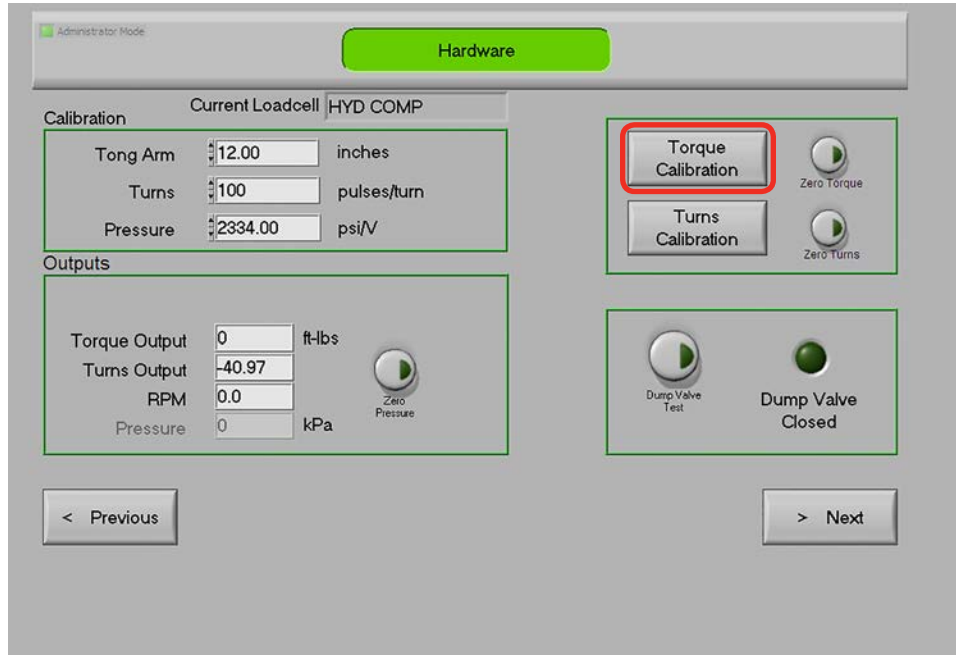

Illustration 4.2.1: Hardware Screen - Torque Calibration

2. Open the drop-down menu beneath the "Instrument Name" field to show the load cell calibration files recorded on the WINCATT® system.

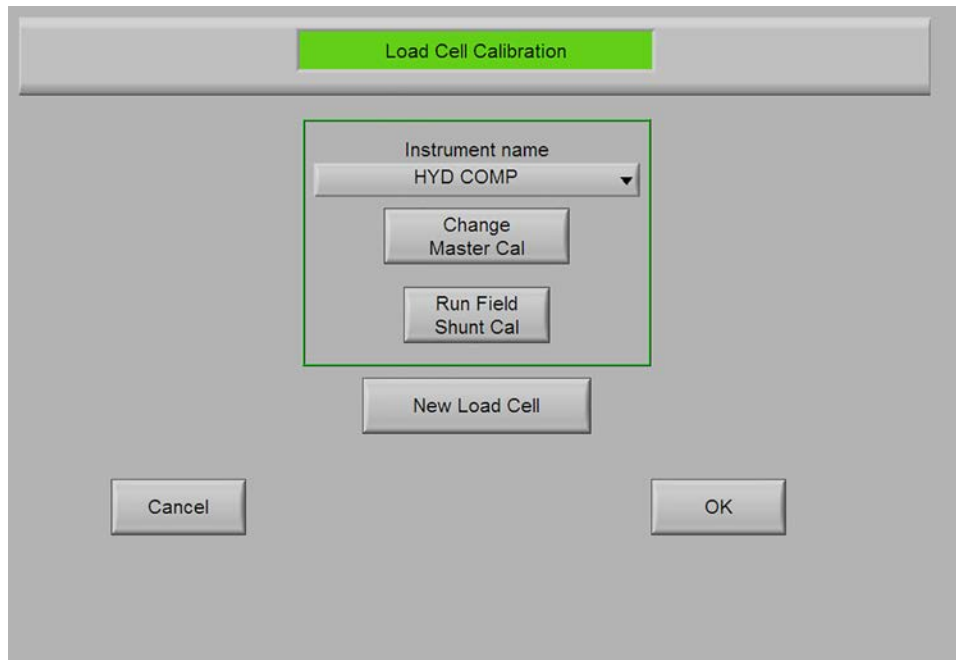

Illustration 4.2.2: Load Cell Selection

4.2.1 Selecting & Testing A Load Cell (Continued):

3. Select the load cell calibration file that matches the physical load cell used on the tubular connection equipment. McCoy Global identifies the calibration performed on a particular load cell by the serial number located on the physical load cell. In the event two or more similar load cells calibrations have been recorded select the correct calibration file by matching the serial number in the calibration file name with the serial number on the physical load cell.

Select "OK" to return to the Hardware page.

4.2.2 Calibrating Turns Counter Encoder

Turns counter calibration requires that the tubular connection equipment be active (hydraulic power supplied) and ready to rotate.

1. Ensure the turns counter encoder has been properly installed on the tubular connection equipment (see section 3.1.1). Confirm encoder operation by rotating the tong and observing the "Turns Output" and the "RPM" fields on the Hardware screen, outlined in red in illustration 4.3.3.

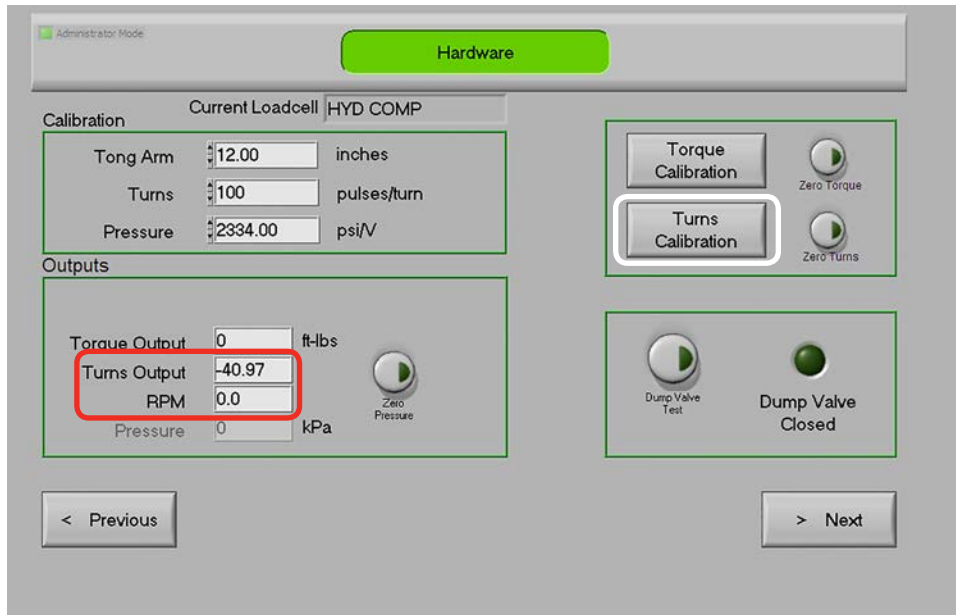

Illustration 4.2.3: Turns Counter Calibration 01

Increasing numbers in these fields are indicative of correct encoder operation.

2. Counting rotations during a calibration is a manual process; that is, the starting position of the rotary gear must be noted before rotating, and the number of rotations must be counted manually. McCoy Global recommends performing this task with the tong in low gear and (if applicable) low motor speed.

NOTICE

PERFORM THIS TASK IN LOW GEAR AND (IF APPLICABLE) LOW MOTOR SPEED

McCoy recommends simplifying the process by noting a definitive and easily observed starting point. For example, aligning the rotary gear with the tong opening before beginning calibration provides an easily identifiable start/finish point when rotating.

Once the rotary assembly has been set to the "start" point do not further rotate equipment until instructed to do so in this procedure.

4.2.2 Calibrating Turns Counter Encoder (Continued):

3. Begin encoder calibration by selecting “Turns Calibration” on the Hardware screen (outlined in yellow on illustration 4.3.3) to launch a pop-up window in which the parameters for the calibration may be entered.

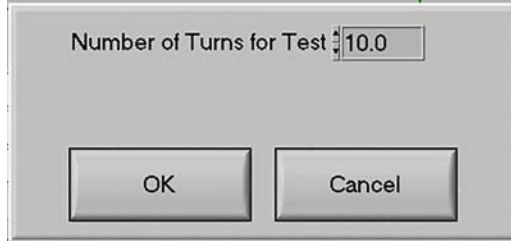

Illustration 4.2.4: Turns Counter Calibration 02

Enter the desired number of complete rotations of the hydraulic power tong for the purpose of calibrating the turns counter encoder in the “Number of Turns for Test” field. The default loaded value is “10”. McCoy Global recommends between 5 and 10 revolutions to ensure an accurate calibration.

4. Selecting “OK” launches a warning dialogue box requesting that the user ensures that the tong is in a “starting” position.

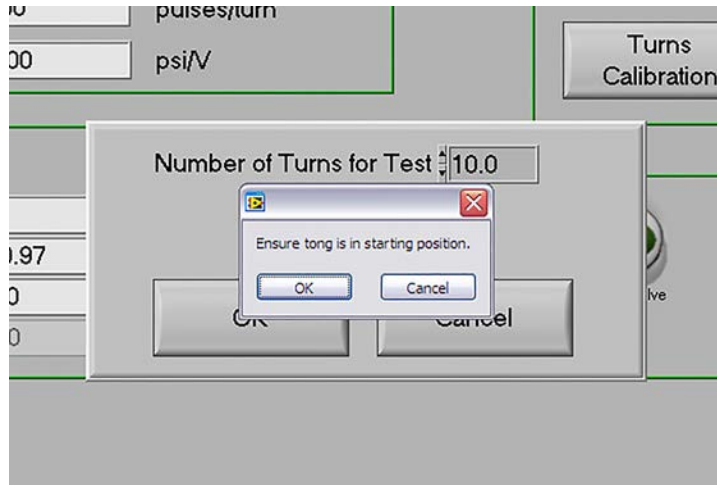

Illustration 4.2.5: Turns Counter Calibration 03

5. Selecting “OK” on the warning dialogue box launches a “status” dialogue box indicating the number of turns selected for a test, the number of current turns recorded. Note that for the purposes of calibrating the encoder the value shown in the “current turns” field is not relevant to the calibration. Enter the number of complete rotations of the hydraulic power tong in the “Number of Turns for Test” field. The default loaded value is “10”. McCoy Global recommends between 5 and 10 revolutions to ensure an accurate calibration.

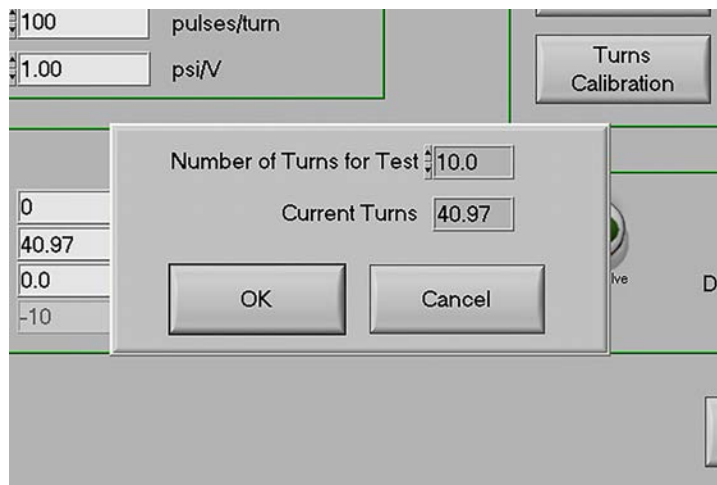

Illustration 4.2.6: Turns Counter Calibration 04

4.2.2 Calibrating Turns Counter Encoder (Continued):

- Begin rotation of the tong, and rotate for the number of complete revolutions programmed in Step #3. NOTE: Once beginning rotation of the tong, do not reverse direction even if the Start/Stop location (as noted in Step 2) is over-shot. Reversing direction of rotation requires re-starting the turns counter encoder calibration process.

NOTICE

ROTATE IN ONE DIRECTION ONLY. DO NOT REVERSE ROTATION DURING CALIBRATION PROCESS

McCoy Global recommends stopping rotation a few degrees short of the previously noted start/stop location on the final revolution, and then incrementally advancing the rotary section in the same direction until the start/stop position is reached. When the start/stop position is reached select “OK” on the dialogue box to launch the calibration confirmation dialogue box.

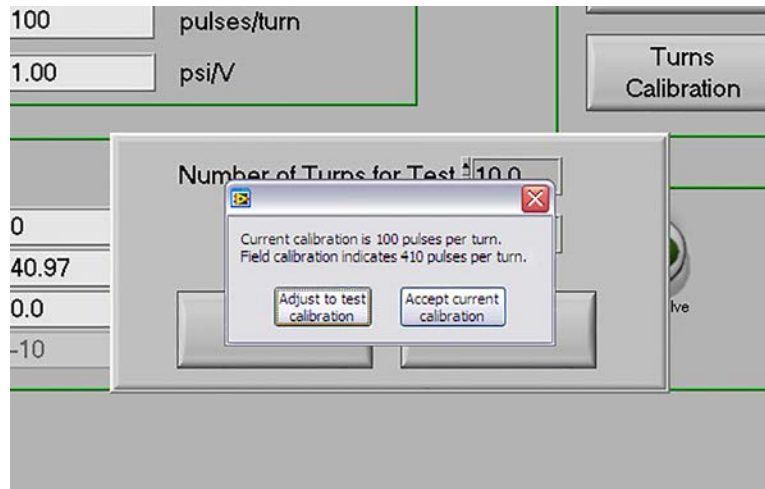

Illustration 4.2.7: Turns Counter Calibration 05

- The number of counted pulses during a single rotation of the rotary gear is dependant upon the gear ratio between the gear on which the encoder is mounted and the rotary gear, and upon the rated pulse count per revolution of the encoder. The calibration confirmation dialogue box indicates the calculated number of pulses per revolution of the rotary gear from the encoder recorded during the field test just performed (called “Field calibration”), and also the most recent previous calibration (called “Current calibration”). These values may vary widely depending on previous software settings, if the encoder has been replaced, or if this is the initial calibration of the system. McCoy Global recommends selecting “Adjust to test calibration”, and also recording this value to compare to future calibrations. The software immediately returns to the Hardware screen.

The Hardware screen now reflects the result of the newly accepted encoder calibration:

- the “Turns” field in the Calibration section of the screen displays the current pulses/turn
- the “Turns Output” field in the Outputs section of the screen displays the most recent number of turns

If desired the most recent encoder calibration can be verified:

- select the “Zero Turns” button
- rotate the rotary section for one turn
- confirm that the “Turns Output” field in the Outputs section of the screen displays “1.00”

Repeat the turns counter calibration if the verification process produces an unexpected or inaccurate result.

NOTICE

LARGE VARIANCES IN THE “PULSES PER TURN” INDICATION WHEN PERFORMING SEQUENTIAL ENCODER CALIBRATIONS INDICATES MECHANICAL SLIPPAGE BETWEEN THE TONG GEAR AND THE ENCODER SHAFT. REMOVE HYDRAULIC POWER AND CHECK ALL MECHANICAL CONNECTIONS ON THE ENCODER AND MOUNT ASSEMBLY.

4.2.2 Calibrating Turns Counter Encoder (Continued):

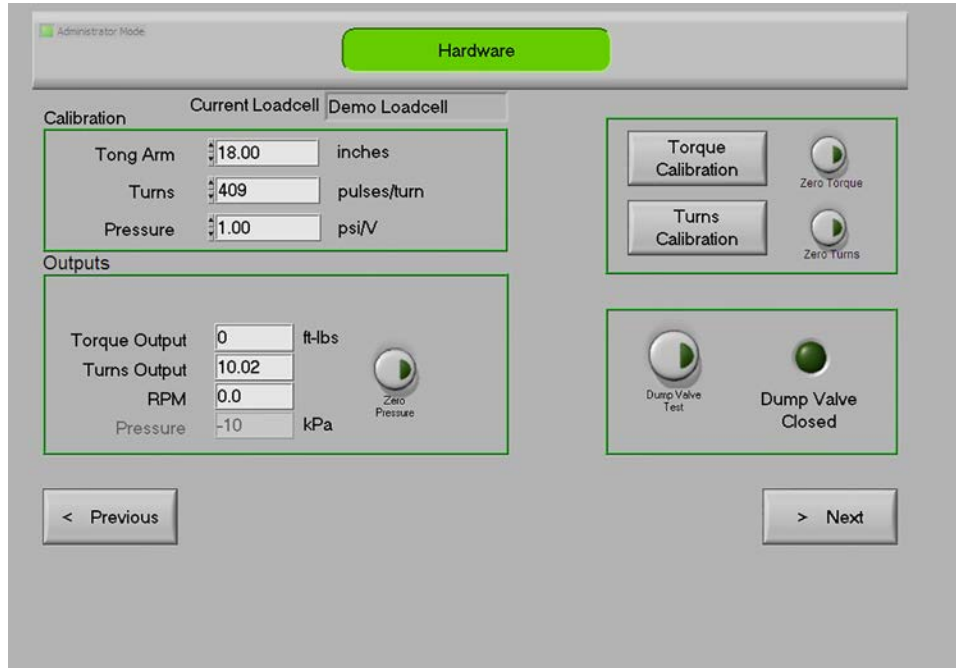

Illustration 4.2.8: Turns Counter Calibration 06

4.2.3 Dump Valve Test

This test activates the “dump valve” on the incoming hydraulic pressure line of the tubular connection equipment. Opening the valve immediately diverts (i.e. “dumps”) pressurized hydraulic fluid to the tank line, interrupting hydraulic-powered activity on the equipment.

1. Begin rotation of the tong (direction of rotation is not important).
2. Click the “Dump Valve Test” button on the Hardware screen.

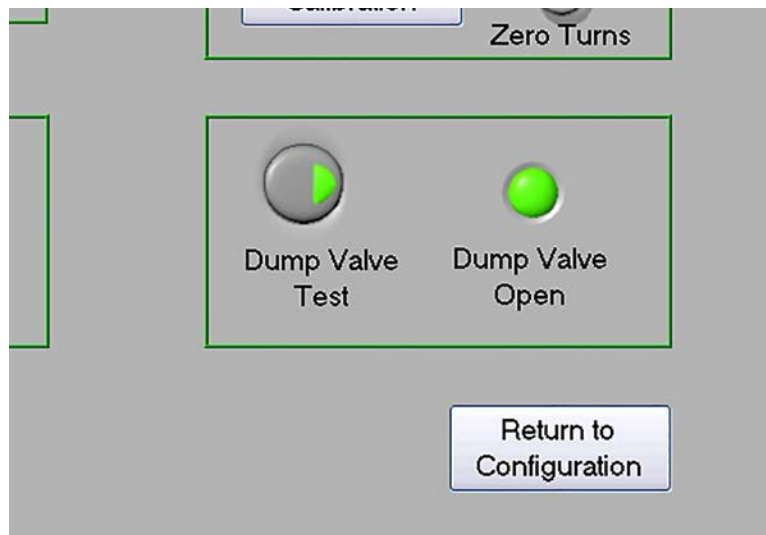

Illustration 4.2.9: Testing Dump Valve

The “Dump Valve Open” indicator shown in illustration 4.3.9 changes state to bright green. Confirm the dump valve has physically opened by noting the rotation of the tubular equipment. When the dump valve opens the equipment rotation will slow dramatically or stop completely. If opening the dump valve has no physical effect on the equipment stop rotation, confirm that all electrical and hydraulic connections have been properly made, and repeat the dump valve test. If repeated dump valve tests do not have a noticeable impact on the equipment operation please contact McCoy Global’s WINCATT® service department.

4.3.4 Torque Output Test

This test confirms that applying force to the torque gauge results in a positive torque indication in the “Torque Output” field in the “Outputs” section of the System Hardware screen.

1. Enter the tubular connection equipment torque arm length in inches in the “Tong Arm” field in the “Calibration” section of the Hardware screen. The torque arm length is found in the “Specifications” section of the tubular connection equipment technical manual.

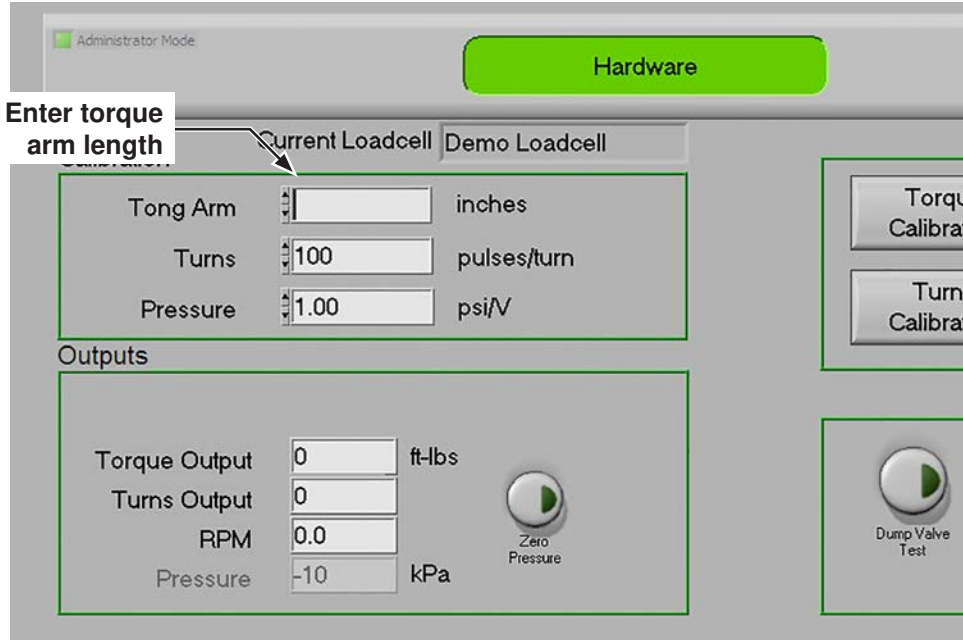

Illustration 4.3.10: Torque Arm & Torque Output

2. Apply linear force to the load cell. A compression load cell requires compression (“squeezing”) force to provide a positive torque output, while a tension load cell requires extension (“stretching”) force to provide a positive torque output.

Testing a Compression Load Cell

McCoy Global recommends placing a connected compression load cell flat on a sturdy surface and applying weight to the load cell plunger. The exact amount of weight is not critical, but apply enough weight to ensure a measurable and repeatable positive torque output.

Testing a Tension Load Cell

McCoy Global recommends hanging a connected tension from a suspension line or utility winch, and hanging a weight from the load cell plunger. The exact amount of weight is not critical, but apply enough weight to ensure a measurable and repeatable positive torque output.

Note that the above tests are for confirmation of positive torque output only, and are not intended to be an accurate reference check. If a reference check is required please see “Reference Checking the Load Cell” in the maintenance section.

4.3.5 Setting System Options

3. Select "Next" on the Hardware page to advance to the System Options page.

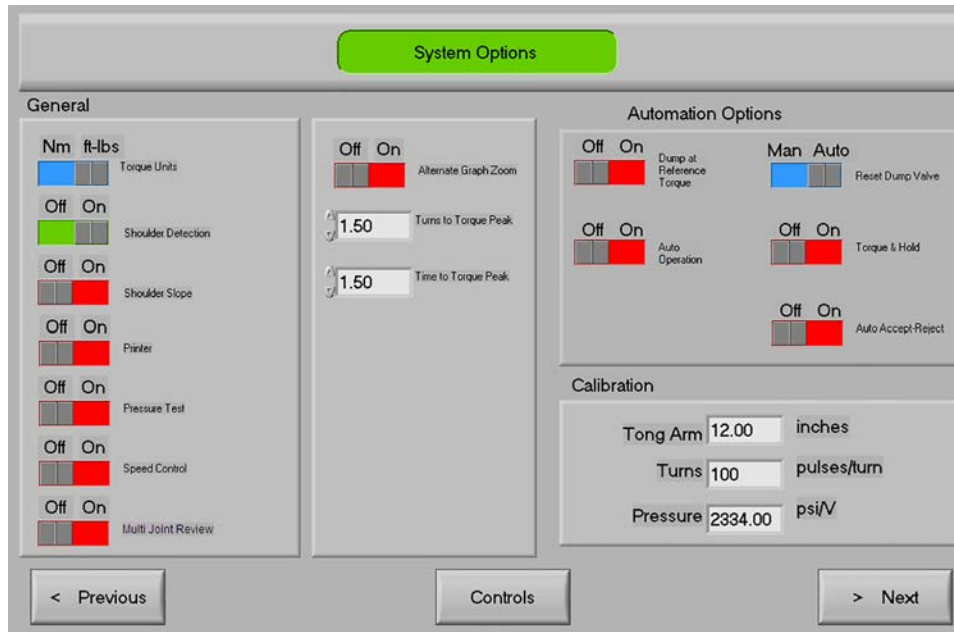

Illustration 4.3.11: Systems Options Screen.

Activate or de-activate each system option by sliding the dark grey virtual switch on each selection field. The background of most fields will turn either green to indicate the option is actively selected, or red to indicate the option is de-selected. The two exceptions are the "Torque Units" and "Reset Dump Valve" options which show blue when "ft-lbs" or "Auto" are selected, and yellow when "Nm" and "Man" are selected.

Torque Units

Select the unit of torque to be displayed. Options are newton-metres (Nm) and foot-pounds (ft-lbs).

Shoulder Detection

Select "On" to allow WINCATT® to set a shoulder point on each joint.

Shoulder Slope

Select "On" when a connection calls for a shoulder slope calculation.

Printer

Select "On" to use the default printer to print a record of each connection following connection.

Pressure Test

Select "On" if the current job requires WINCATT® to perform a pressure test (on equipment fitted with pressure-testing tools).

Speed Control

Select "On" if the current job requires WINCATT® to control rotation speed (on equipment fitted with speed-control equipment). Speed control settings are available in the "Controls" menu.

Multi-Joint Review

Selecting "On" overlays the previous ten connections on the DAC (Data Acquisition) screen following the completion of each connection (see illustration 4.3.12 next page).

4.3.5 Setting System Options (Continued):



Illustration 4.3.12: Multi-Joint Review Displayed On DAC Screen

Alternate Graph Zoom

Turning this option ON produces a graph on the Data Acquisition screen upon completion of a connection on which the peaks of the connection are magnified according to the parameters selected directly below the ON/OFF switch.

Turns to Torque Peak: magnifies the turns graph from the peak torque back “X” number of turns (maximum 1.5 turns).

Time to Torque Peak: magnifies the time graph from the peak torque back “X” number of seconds (maximum 1.5 seconds).

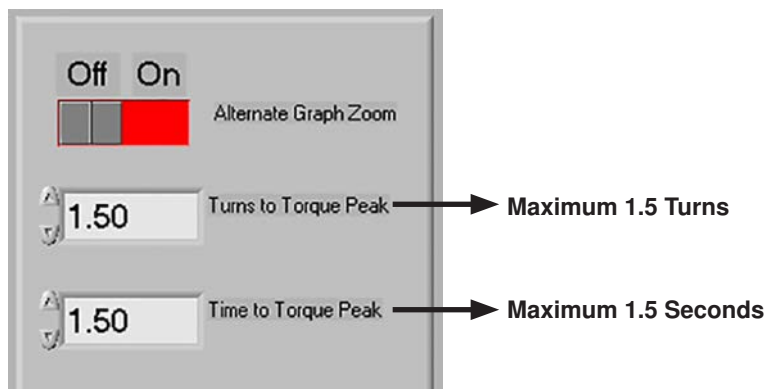

Illustration 4.3.12: Alternate Graph Zoom Options

4.3.5 Setting System Options (Continued):



Illustration 4.3.12: Alternate Graph Zoom Displayed On DAC Screen

Dump at Reference Torque

Selecting "ON" instructs WINCATT® to activate the dump valve when a pre-programmed reference torque is reached.

Auto Operations

Selecting "ON" instructs WINCATT® to begin recording when the following conditions are met:

- pre-programmed reference torque reached
- "auto operation" turns set point reached

NOTE: Auto Operations is not an available option in "Torque vs. Time" mode.

Reset Dump Valve

Selecting "AUTO" instructs WINCATT® to automatically reset the dump valve two seconds after the dump valve has actuated. Select "Man" to manually control when the dump valve is reset.

Torque & Hold

Select "On" if the current job requires torque-and-hold operations (on equipment fitted with torque-and-hold equipment). Torque-and-Hold settings are available in the "Controls" menu.

Auto Accept-Reject

Selecting "On" instructs WINCATT® to automatically accept or reject the most recent connection based on pre-programmed criteria.

After satisfactorily setting all options select "Next" to advance to the Data Acquisition (DAC) page to begin monitoring and recording connections.

4.4 RUNNING A JOB

4.4.1 Resuming A Previous Job

1. Select "Resume Previous Job" on the Home screen to launch the Data Acquisition (DAC) screen and return to the last job run.

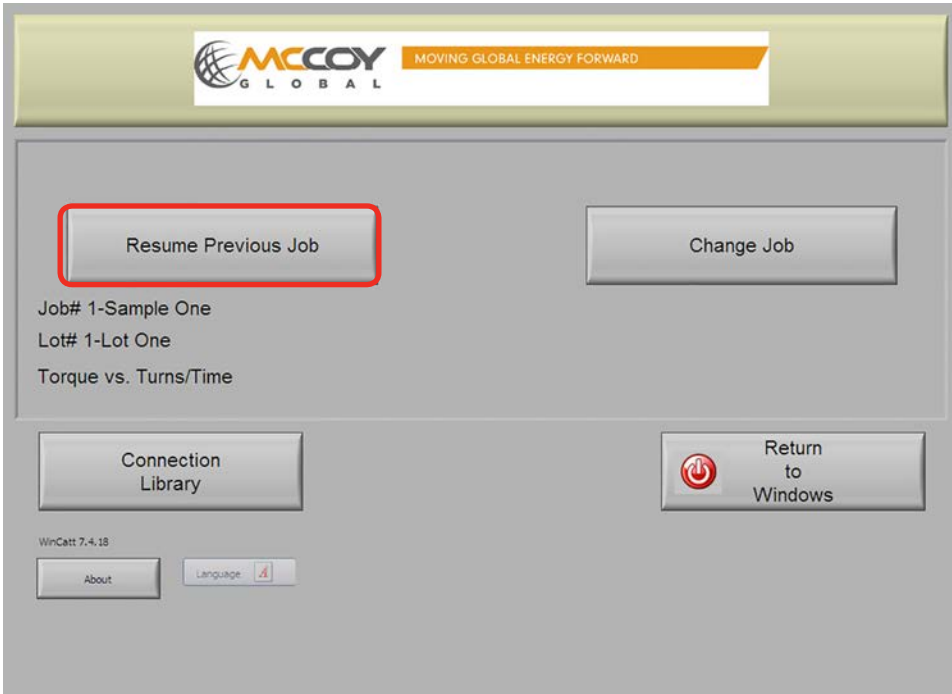

Illustration 4.4.1: Resuming A Job From The Home Screen

2. Select "Start" on the Data Acquisition screen to begin monitoring and recording a connection. Make up the connection with the tubular connection equipment.

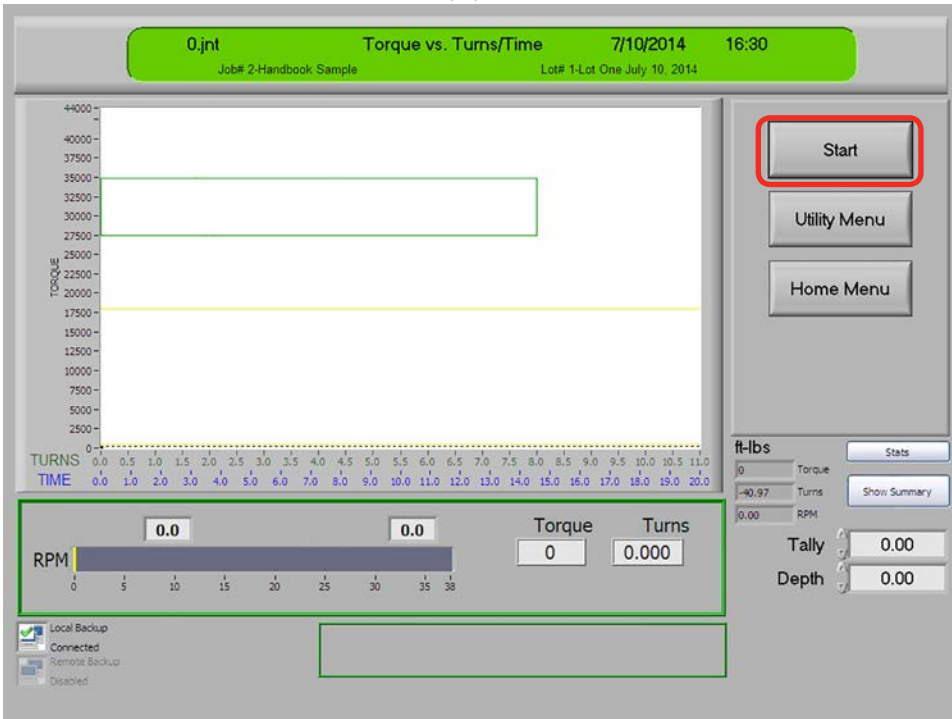

Illustration 4.4.2: Running A Job - DAC Screen

4.4.1 Resuming A Previous Job (Continued):

- The software monitors the measured torque, triggering the dump valve and stopping rotation when it determines the measured torque is about to hit the pre-programmed torque value. WINCATT® immediately generates a graphical report including the software’s recommendation to either accept or reject the connection based on pre-programmed parameters. Select “Accept” to accept a satisfactory connection or “Reject” to reject the connection. **OPERATING NOTE:** A connection may still be accepted even when the software recommends rejection.

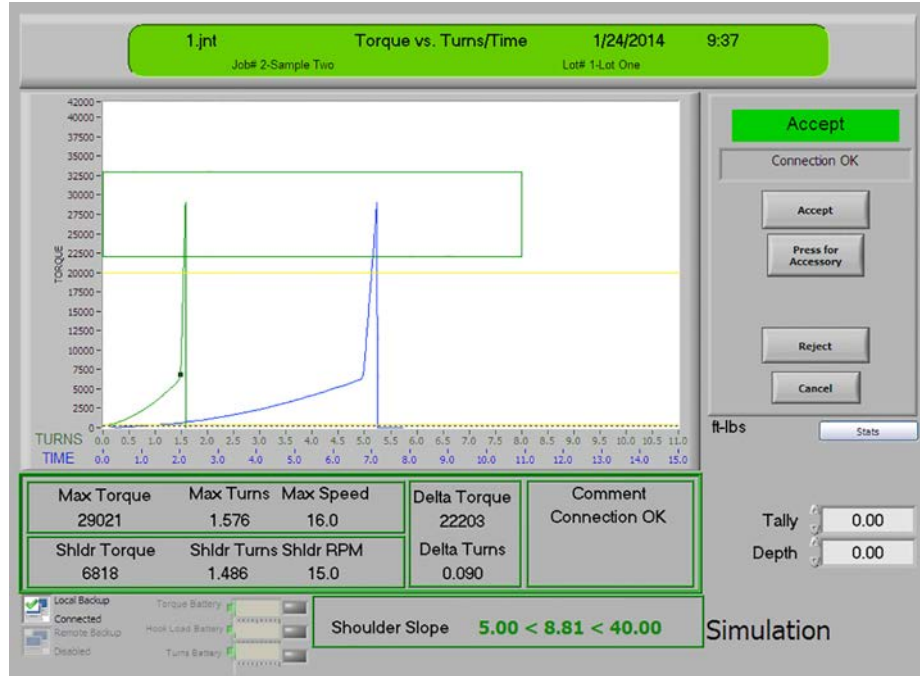

Illustration 4.4.3: WINCATT® Recommends Accepting Connection - DAC Screen

Selecting “Accept” invokes a small menu on which a connection comment must be selected in order to proceed. Select the preferred comment, followed by “Accept Comment” to return to the DAC screen to monitor and record another connection.

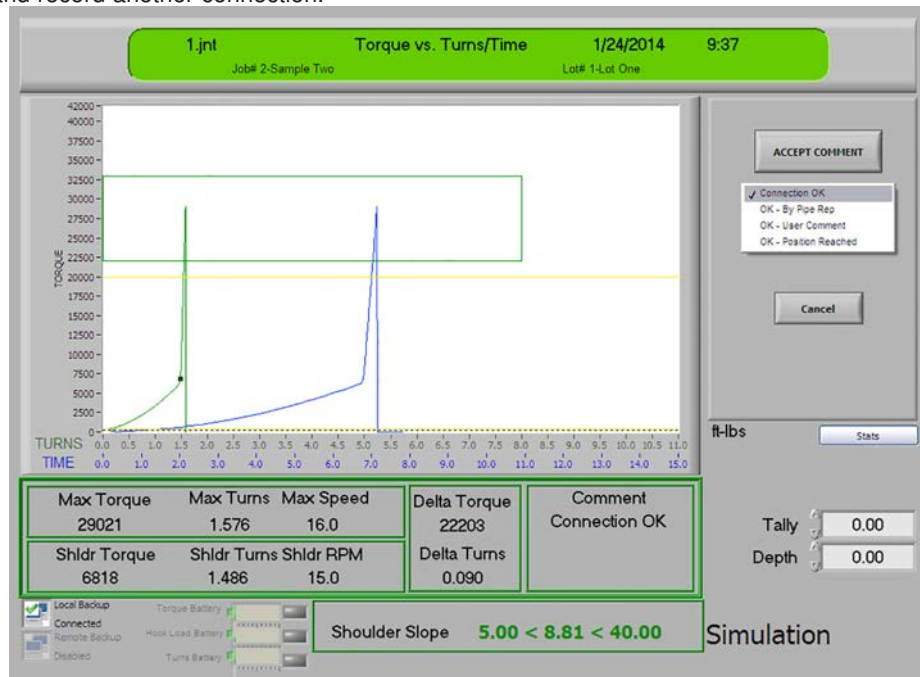

Illustration 4.4.4: Acceptance Comments - DAC Screen

4.4.1 Resuming A Previous Job (Continued):

4. Connection on which the measured parameters fall outside the programmed values causes the software to recommend rejection of the connection, generating a visual alarm on which “Reject” is displayed on a flashing red/yellow background. Selecting “Accept” generates a screen as seen in illustration 4.4.4, at which time the operator may record acceptance comments and proceed to the next connection. Selecting “Reject” generates the screen shown in illustration 4.4.6.

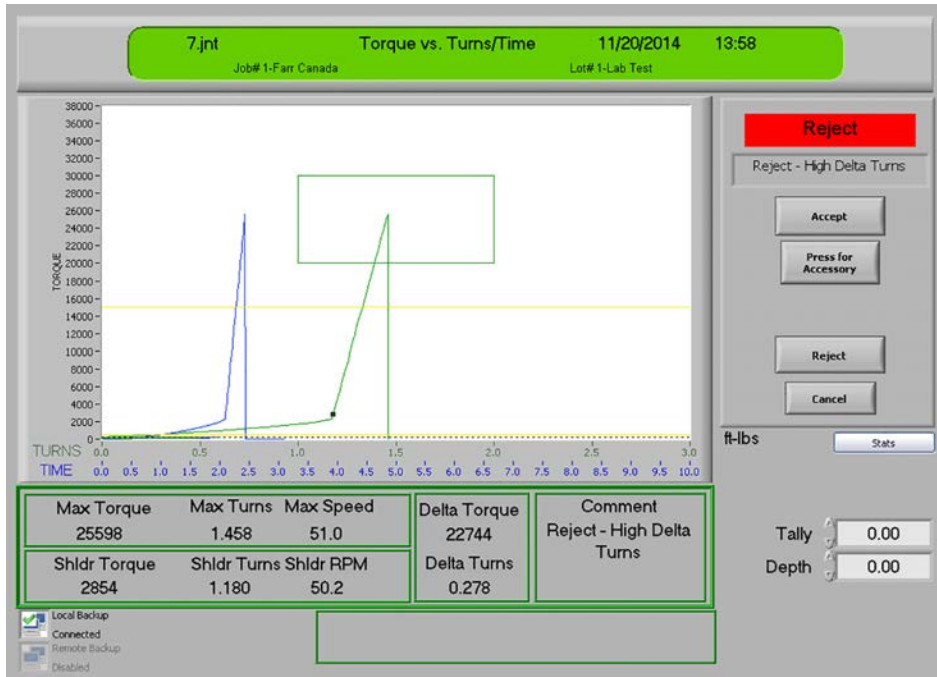

Illustration 4.4.5: WINCATT® Recommends Rejecting Connection - DAC Screen

Select the preferred comment, followed by “Accept Comment”. Note that one of the selections in the drop-down menu is “Reject - User Comment”. Selecting this item enables the operator to record a unique reason for rejection. Select “Accept Comment” to return to the DAC screen to re-work the connection, or otherwise process the connection as determined by company policy.

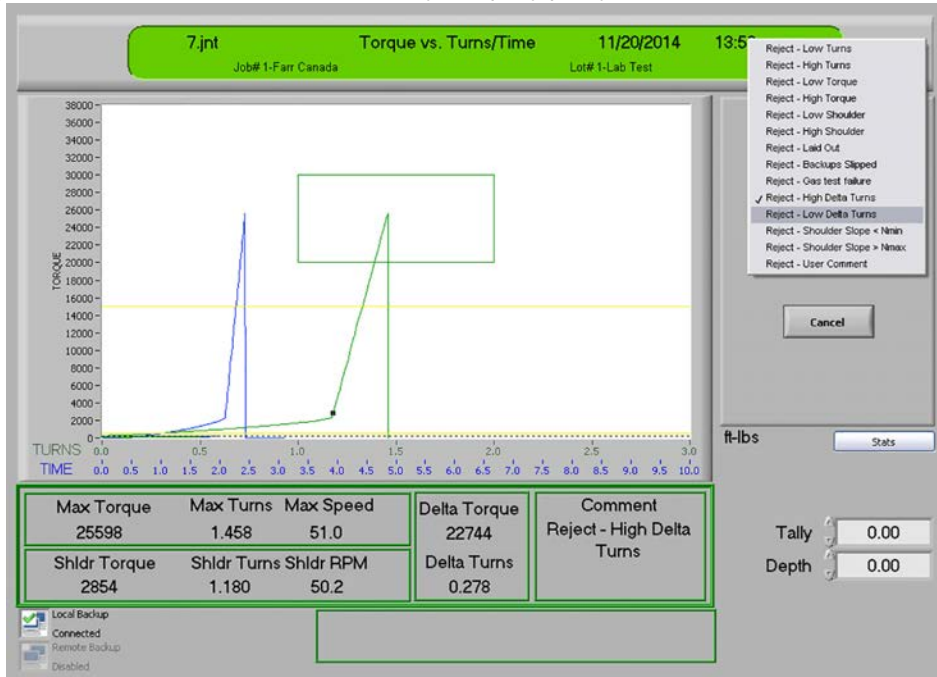

Illustration 4.4.6: Rejection Comments - DAC Screen

4.4.1 Resuming A Previous Job (Continued):

- Enabling “Shoulder Detection” in System Options prompts the software to generate a shoulder point adjustment screen similar to the what is displayed in illustration 4.4.3, allowing the operator to immediately adjust the shoulder point if necessary. Toggling the Selection/Zoom switch to “Zoom” allows the user to draw a zoom box around the desired portion of the display. Releasing the stylus from the screen automatically expands the zoom box to full screen. Toggle the Selection/Zoom switch back to “Select” to directly select the preferred shoulder detection point on the zoomed window (illustration 4.4.4). Select “Reset Scale” to return to the original graph.

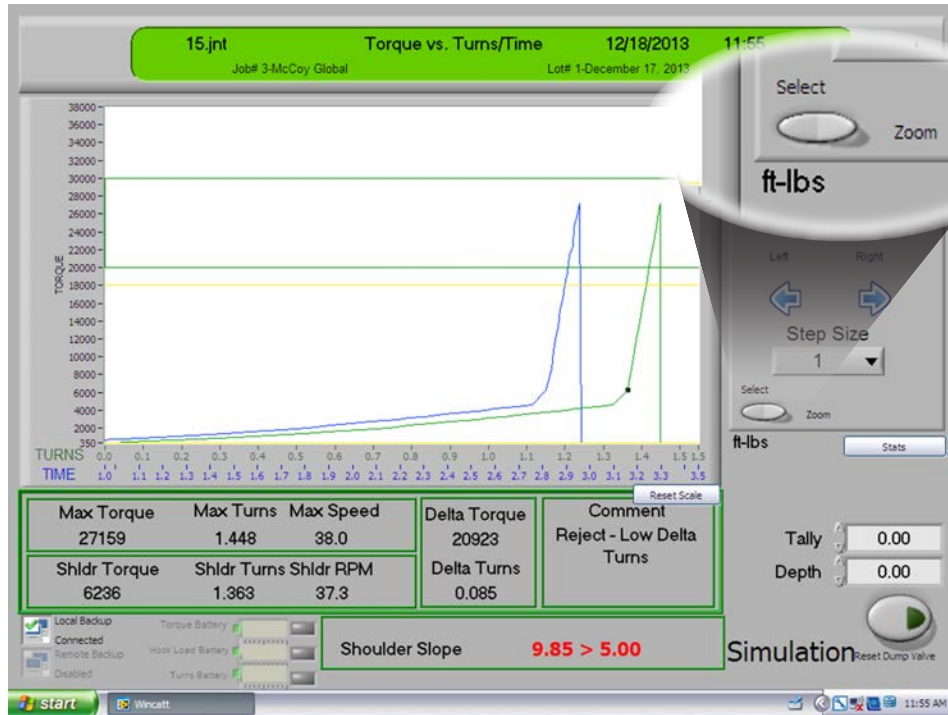

Illustration 4.4.7: Shoulder Point Select/Zoom - DAC Screen

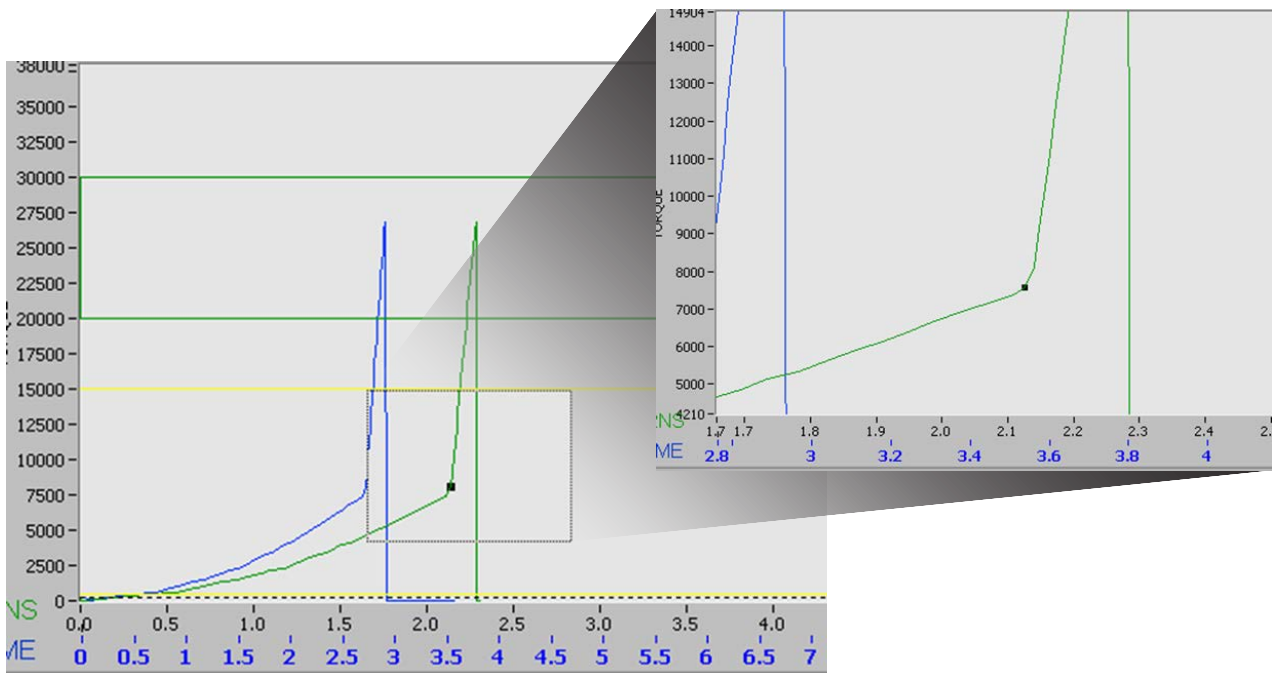

Illustration 4.4.8: Shoulder Point Adjustment - Zoom Window

4.4.2 Utility Menu

Use the utility menu to access a variety of in-job options including hardware tests, software parameter changes, editing system options, and printing job reports.

Select "Utility Menu" from the DAC screen to launch the Utility Menu.

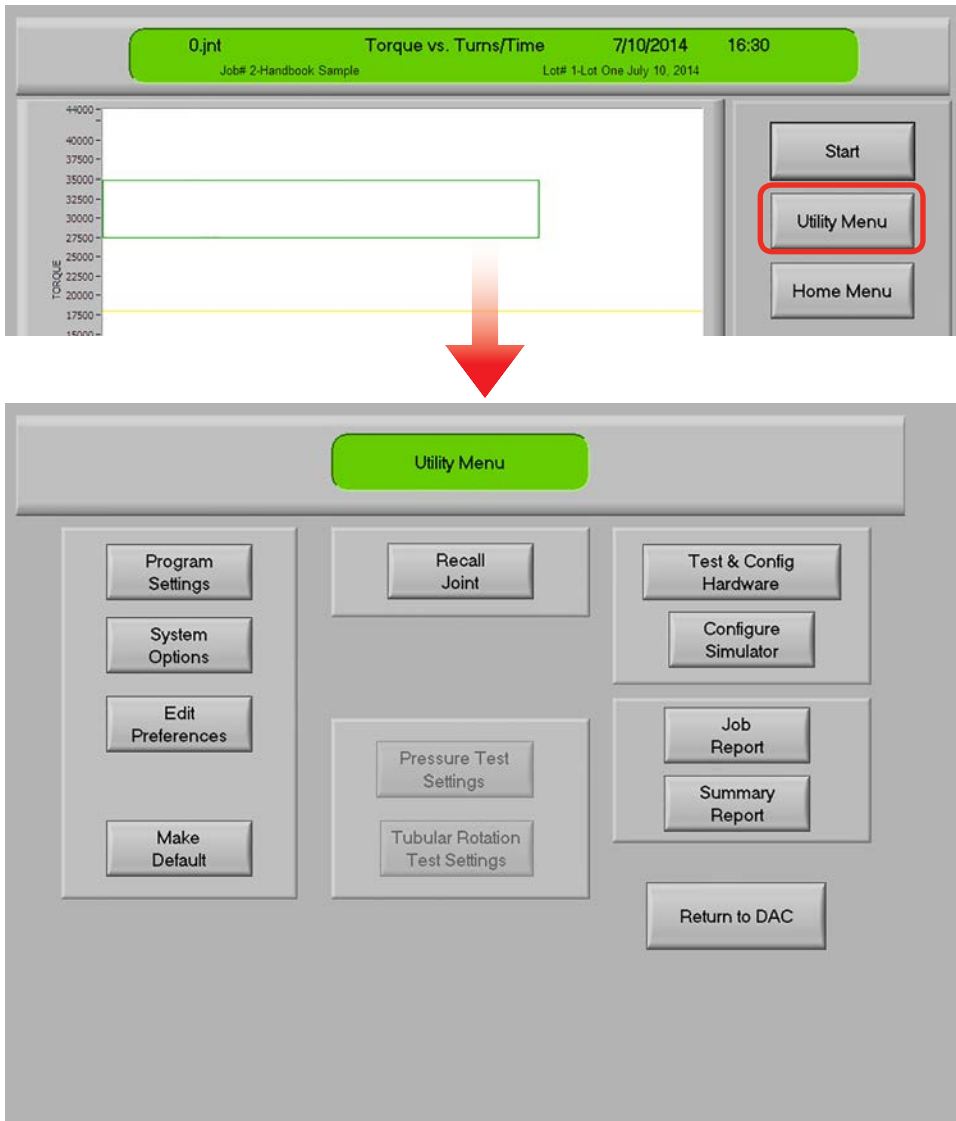

Illustration 4.4.8: Launching Utility Menu

4.4.3 Generating A Job Report

Select "Job Report" to launch the Job Report screen, which enables an operator to record additional specific details about the current job.

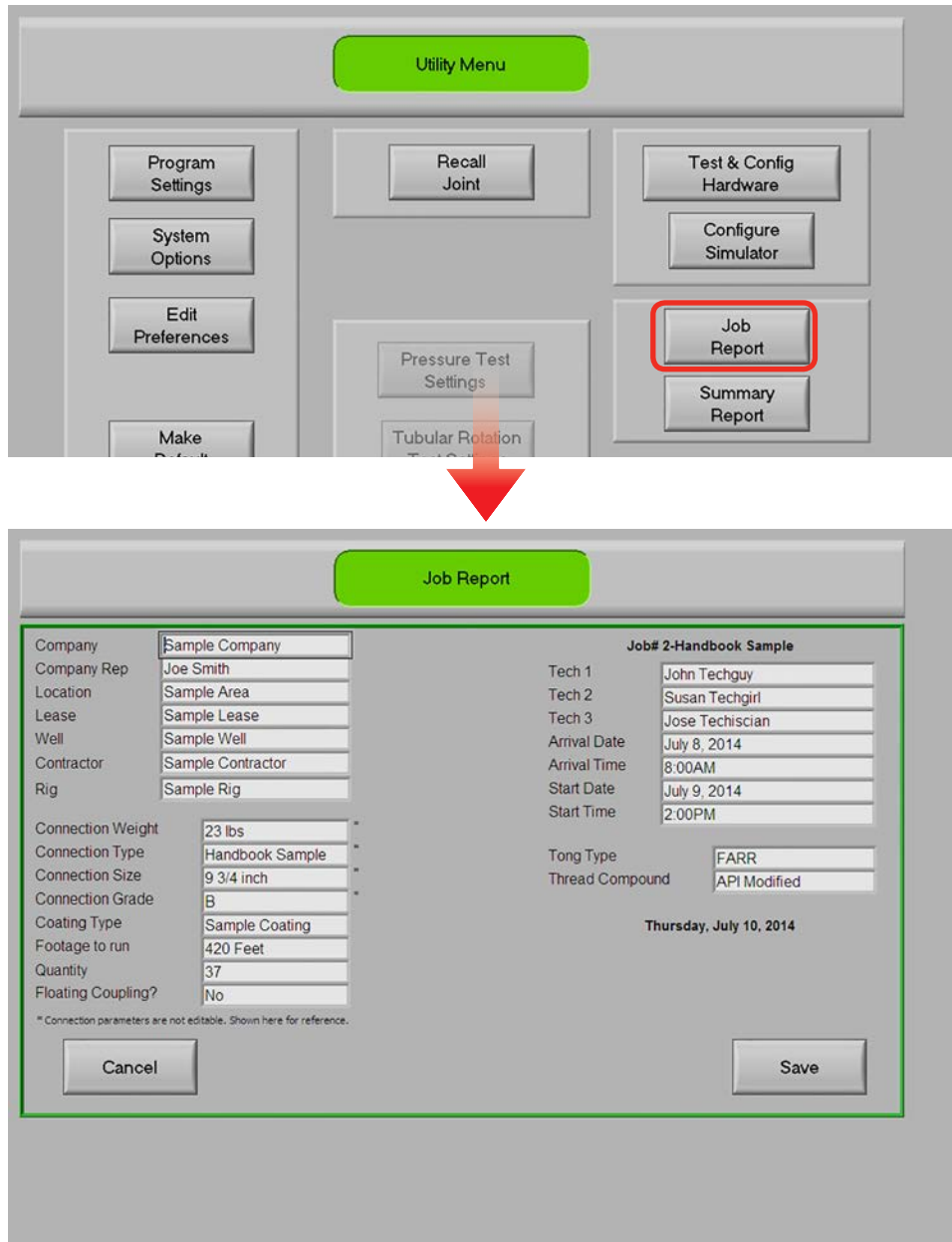

Illustration 4.4.9: Launching Job Report

Note that pipe connection details previously recorded in the connection library are automatically loaded in to the job report

4.4.4 Printing A Summary Report

Select “Summary Report” to launch the Summary Report screen, which enables an operator to choose the information that will be printed.

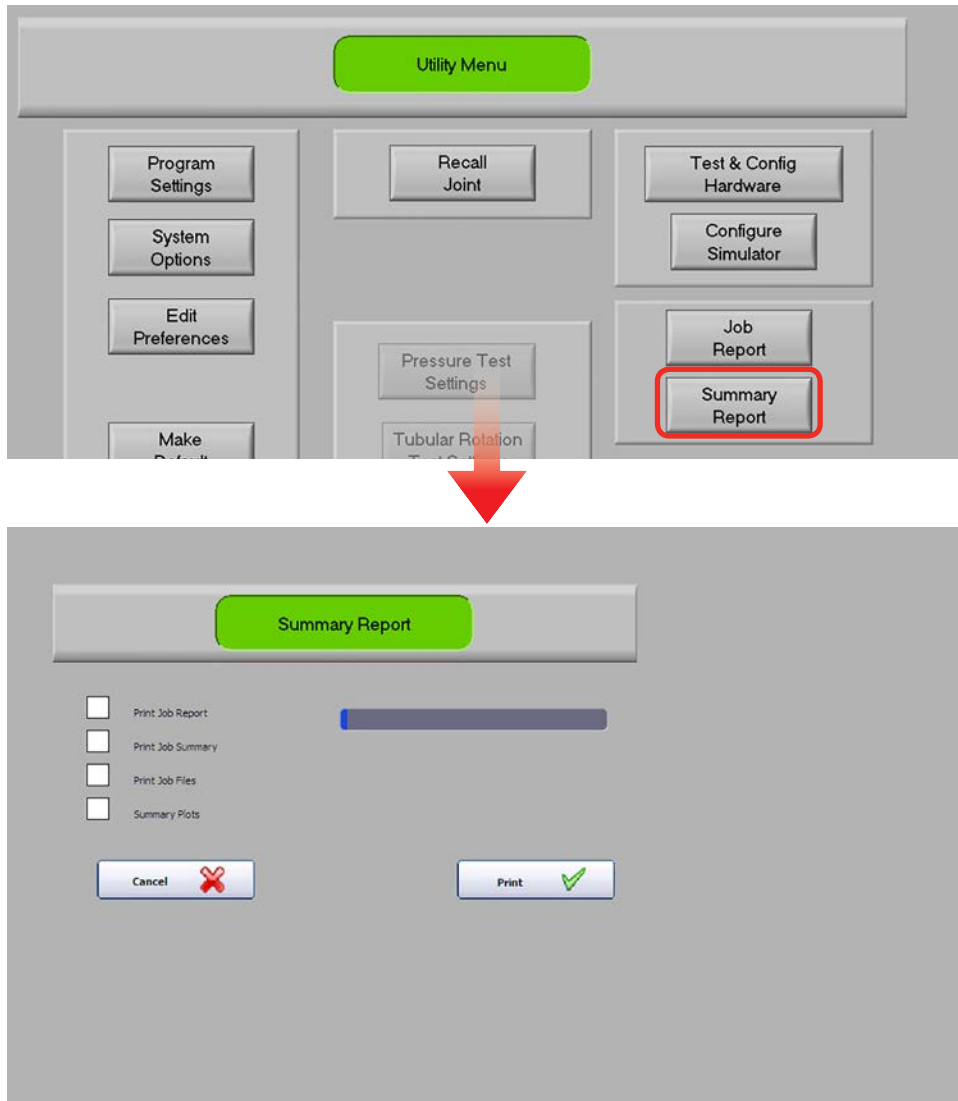

Illustration 4.4.10: Launching Job Report

Any combination of modules may be selected. Select “Print” to begin the print process, which combines and “prints” the summary report to a PDF file on the computer. The report may be physically printed by opening and printing the report using PDF-viewing software. Note that selecting “Print Job Report” will launch the Job Report screen (sub-section 4.4.3) when initiating the print process, allowing the operator to review and, if required, change any of the fields. Printing will continue after saving the Job Report.

Monitor the progress of the print job with the blue status bar. A “Summary Report Complete” notification pops up upon completion of the report.

Locate the WinCatt Data folder on the Windows desktop, and double-click to open (see illustration 4.4.11). Identify the folder that matches the job type for which you are looking for connection data:

T_T_T = Torque vs. Turns/Time

T_Turn = Torque vs. Turns

T_Time = Torque vs. Time

4.4.4 Printing A Summary Report (Continued):

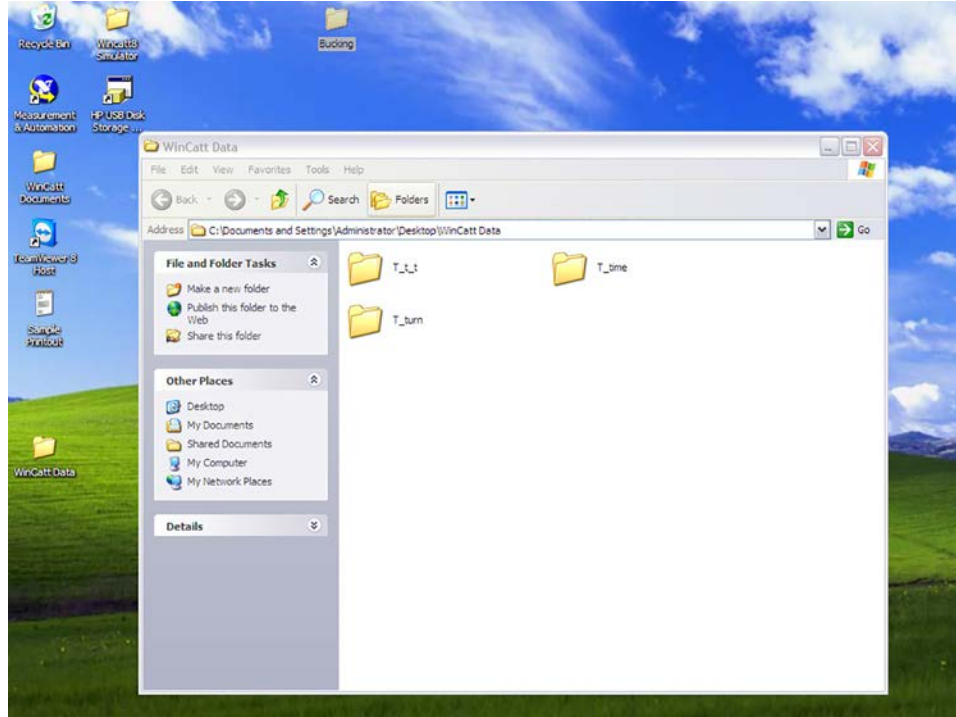

Illustration 4.4.11: WinCatt Data Folder

Double-click on the selected folder to open. Select the folder matching the job for which you want to print a report. For example, if your selected job is Job #1, select the Job #1 folder. Double-click to open the folder. All job and summary reports for Job #1 are located in this folder.

4.4.5 Bucking Mode

WINCATT® 7 includes “Bucking mode” to aid bucking unit operators. **OPERATING NOTE:** “Bucking” mode is only available following the first use of the WINCATT® 7 software.

NOTICE

BUCKING MODE IS AVAILABLE FOR USE FOLLOWING THE FIRST USE OF WINCATT® 7

Follow these steps to initiate “Bucking” mode:

1. Exit WinCatt 7 and navigate to the “WinCatt” directory on the C:\ drive on the computer.
2. Double-click on “PLC.ini” to open that file with Notepad text editor.
3. Replace the phrase “OFF” in the second line with “BUCKING”, then save and close the file.

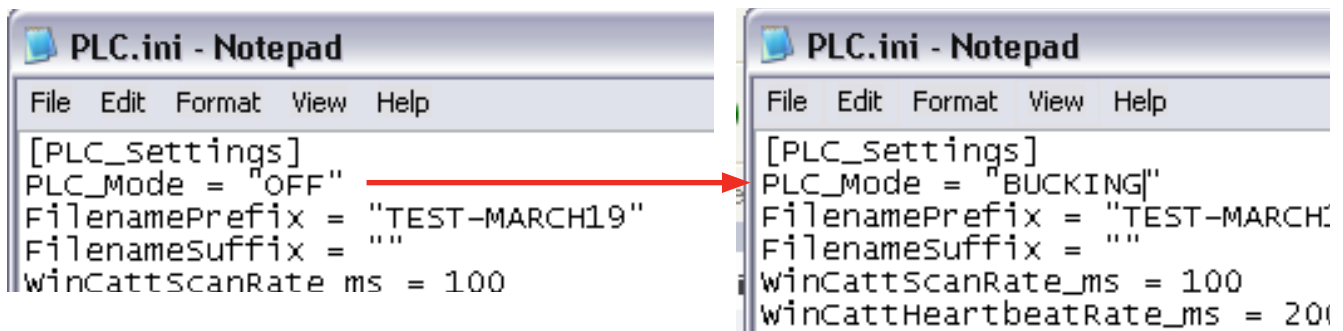

Illustration 4.4.12: Enabling Bucking Mode

4.4.5 Bucking Mode (Continued):

Launching WINCATT® 7 with “BUCKING” mode enabled immediately pops up a new interface screen, giving the user the choice of using a password-protected “Admin” mode or “User” mode. Selecting “User” mode restricts the ability to edit connection parameters, load cell type, arm length, and several system options, preventing unauthorized modification of critical system settings.

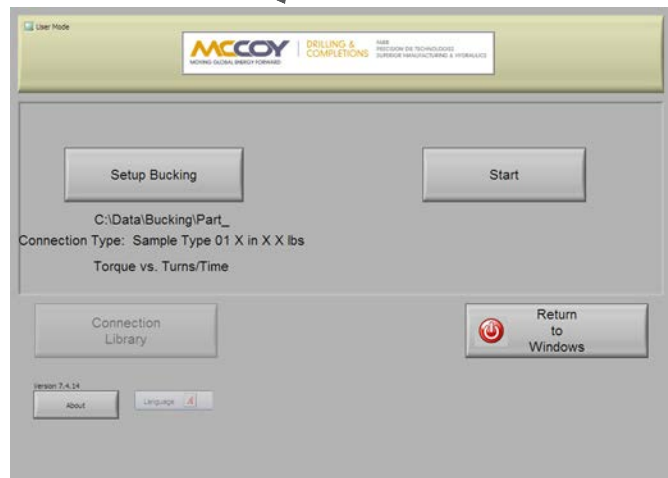
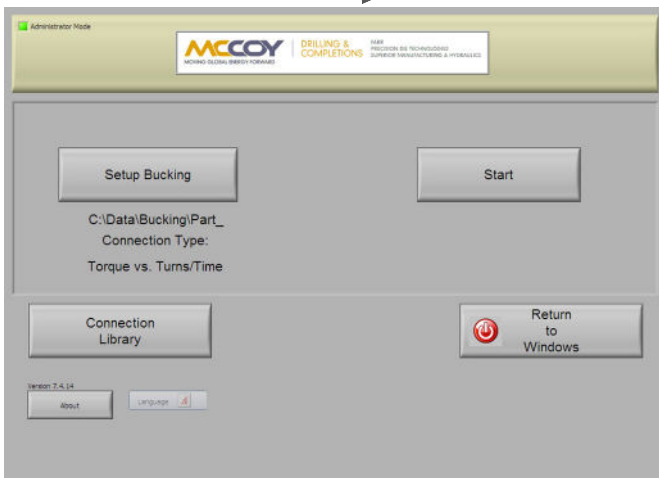

Illustration 4.4.13: Bucking Mode Admin/User Modes

4.4.5 Bucking Mode (Continued):

Select “Setup Bucking” to create a new job, or recall an existing job using the “New Job” or “Old Job” buttons .

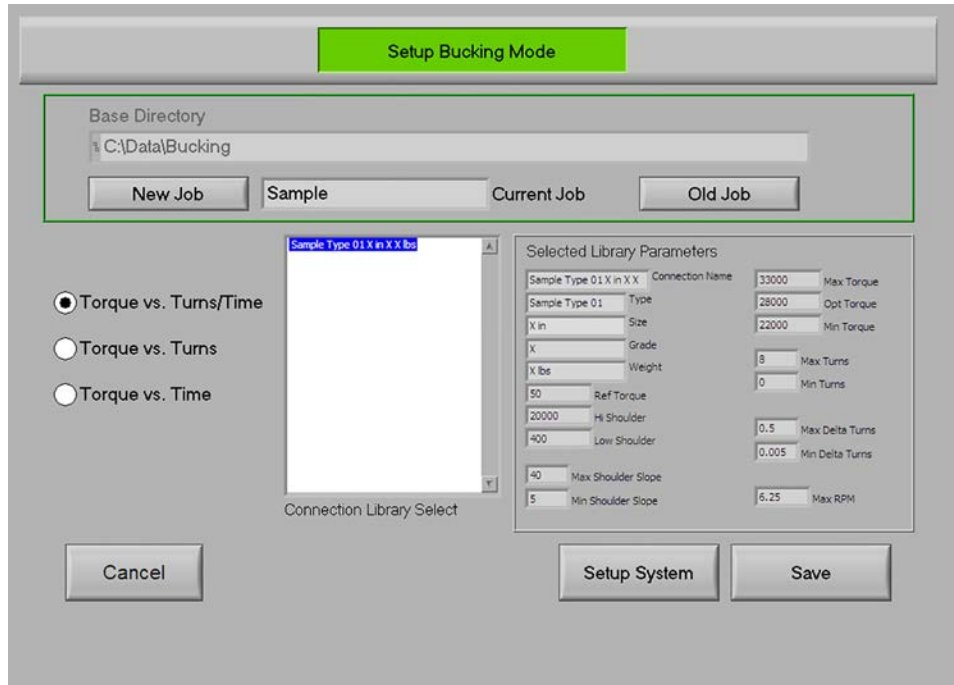

Illustration 4.4.14: Set Up Bucking Mode Screen

Select the job type (“Torque vs. Turns/Time”, “Torque vs. Turns” and “Torque vs. Time”) when starting a new job, locking in that job type until intentionally changed. Select the required connection type from the connection library. Selecting “Save” saves the new job and returns the operator to the home screen.

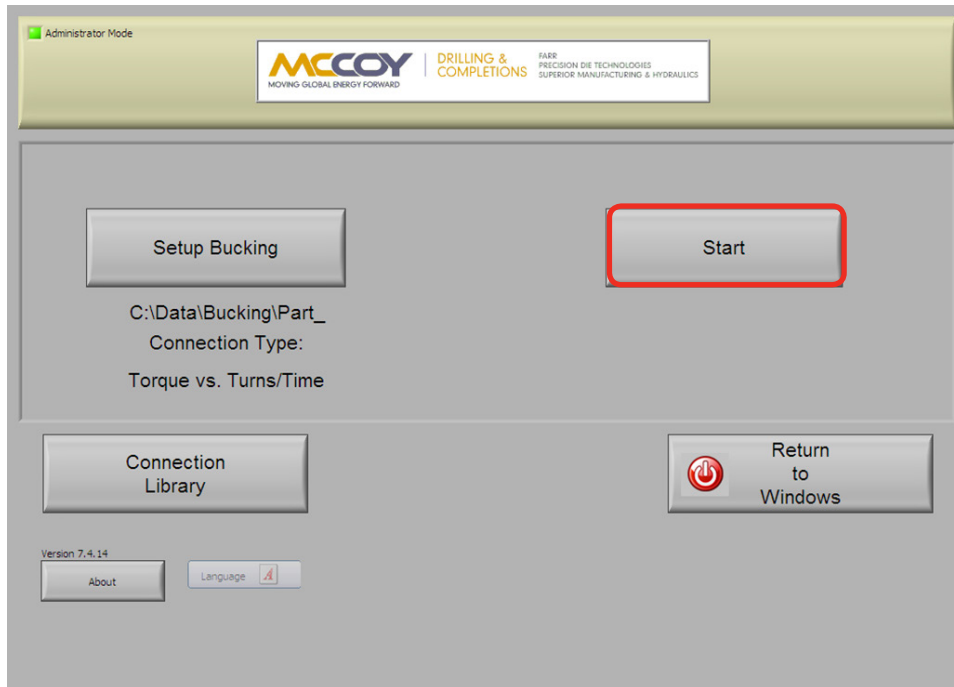

Illustration 4.4.15: Bucking Mode Home Screen

Select “Start” to proceed to the DAC (Data Acquisition) page to begin processing connections (see illustration 4.4.17).

4.4.5 Bucking Mode (Continued):

Selecting “System Setup” on the Set Up Bucking Mode screen opens the setup menu, allowing the operator to test the system hardware (Hardware) and confirm system option settings are correct (System Options).

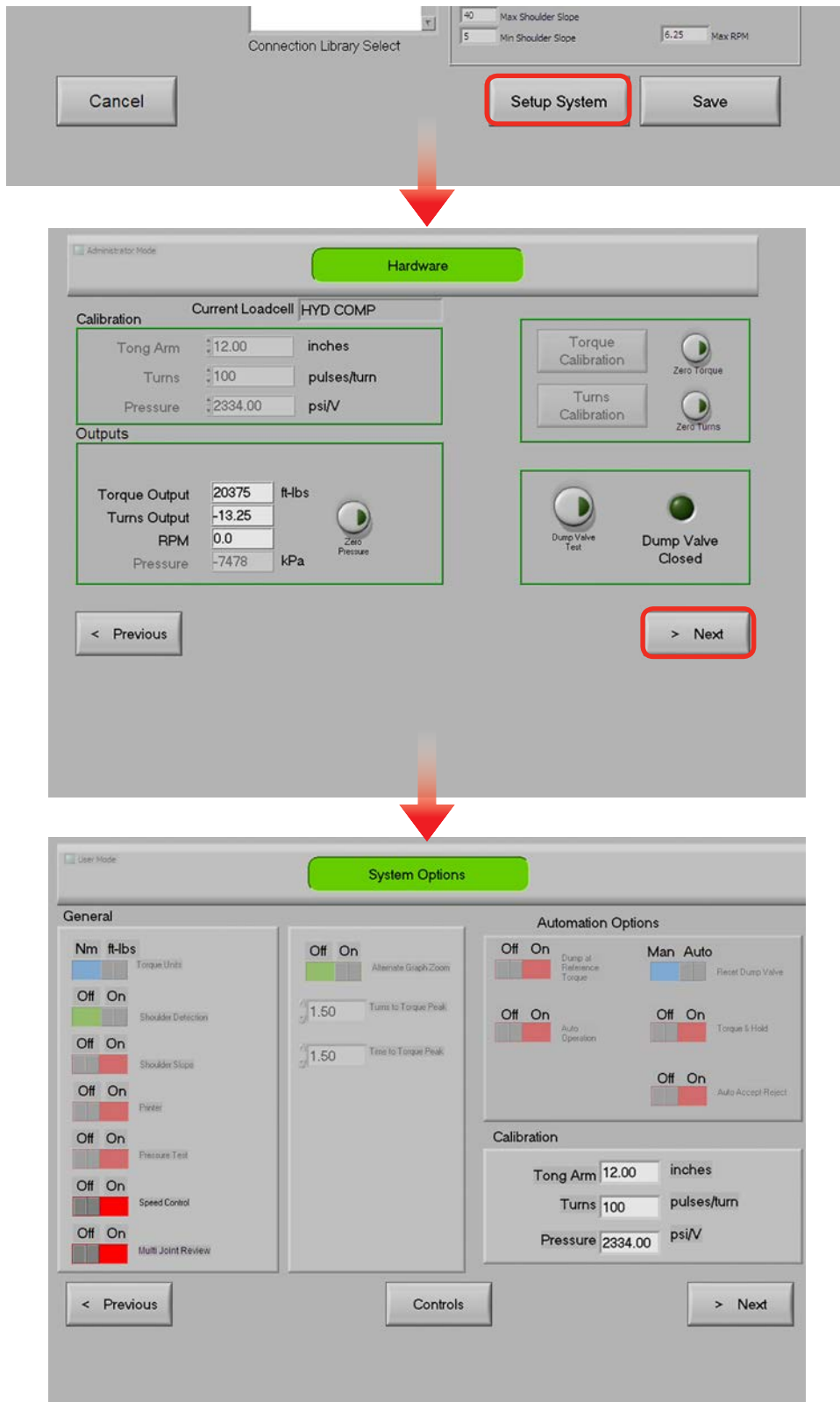

Illustration 4.4.16: Bucking Mode Hardware/System Options

4.4.5 Bucking Mode (Continued):

The “Bucking Mode” Data Acquisition page features a new button labeled “Change Connection”, which enables the operator to easily change a connection type mid-job.

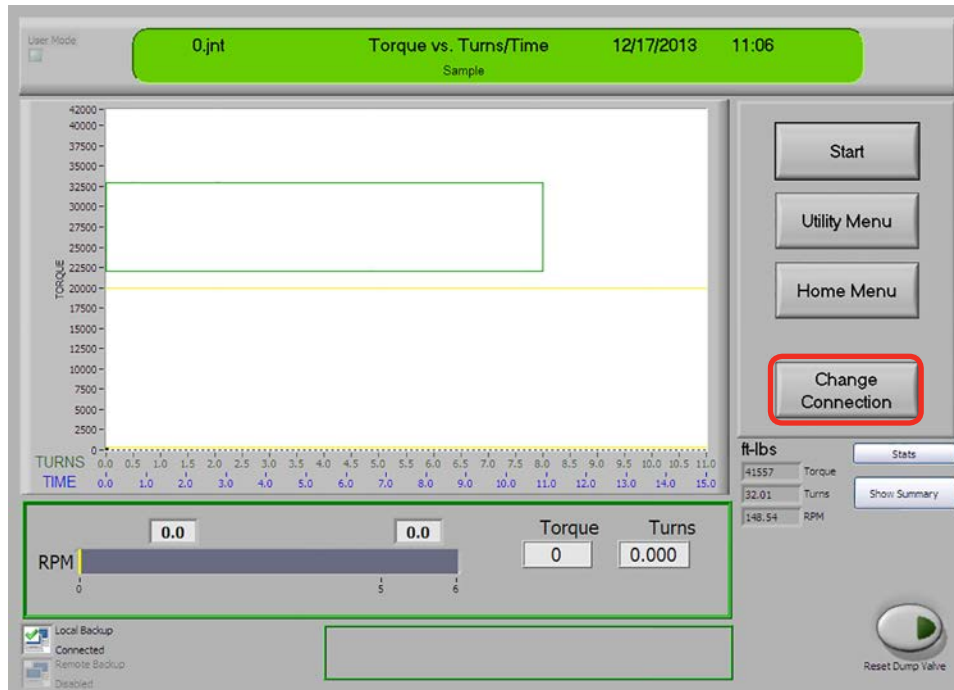

Illustration 4.4.17: Bucking Mode Data Acquisition Screen

Selecting “Change Connection” mid-job invokes the Setup Bucking Mode screen (see illustration 4.4.14), where connection parameters can be modified, or a new connection type selected from the connection library. Following modification of variables selecting “Save” returns the operator directly to the Data Acquisition page, where the job can be immediately resumed.

4.4.6 Redundant Data Storage

Enable redundant data storage on the Preferences screen, which is accessed from the Utility Menu screen. This feature enables the user to set up a redundant, or backup, folder on the WINCATT® computer system, providing easy and automatic storage of duplicate connection reports. McCoy Global recommends using the redundant folder as the working folder, thereby reducing the possibility of accidentally removing or corrupting the original data written to the Data folder on the root directory of the hard drive.

The redundant data storage local path feature is ON by default from the factory, and is configured to write duplicate data to the Windows desktop folder titled “WinCatt Data”. All connection reports are written to this folder.

Data may also be written to a remote storage location (a network drive, for instance), which is a very useful tool when the torque/turn system is used with a bucking unit. Set up data storage to a network folder in exactly the same fashion as for a local folder. Note that reports may be sent to a local and remote folder simultaneously.

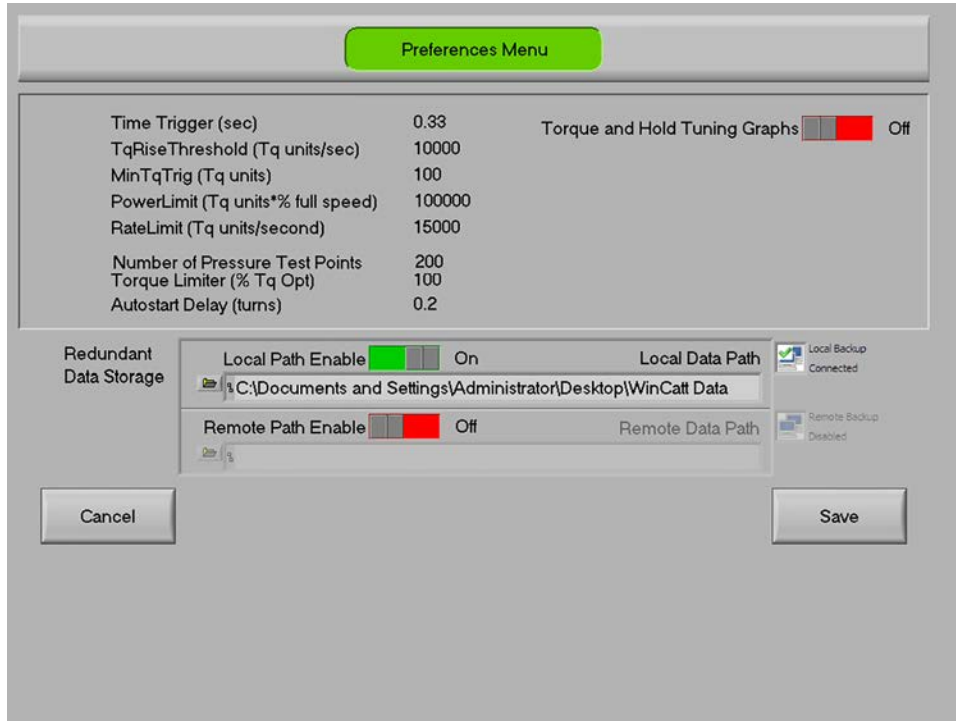

Illustration 4.4.18: Setting Redundant Data Storage Path



SECTION 5: MAINTENANCE



**This page intentionally
left blank**

McCoy Global recognizes that minor on-site repairs and modifications are required to maintain peak operating condition of your equipment, or to match your equipment with the operating environment. Examples of minor repairs are

- filter replacements.
- software updates.
- replacement of fasteners

Any replaced component must be an identical component supplied by McCoy Global. Replaced fasteners must be Grade 8 or equivalent, or whatever fastener is specified by McCoy.

5.0 GENERAL MAINTENANCE SAFETY PRACTICES

The practices identified here are intended as a guideline. All personnel are responsible for performing their tasks in a manner that ensures worker, equipment, and environmental safety, and may require taking additional steps that are not identified in this section.

Do not perform equipment maintenance within a Zone 1 environment. Remove all power, and move the equipment to a convenient workspace outside of Zone 1 before beginning maintenance.



DANGER

REMOVE POWER BEFORE BEGINNING MAINTENANCE

DO NOT PERFORM MAINTENANCE ACTIVITIES WITHIN A ZONE 1 ENVIRONMENT

Equipment maintenance shall be performed only by designated qualified maintenance personnel. Wear all personal protective equipment (PPE) specified by your company's HSE policy, and follow all of your company's safety guidelines. Do not begin a maintenance task without the proper tools or materials on hand, or the proper drawings and documentation necessary.

Schedule planned maintenance with operators to avoid conflicts, unnecessary downtime, and the danger of accidental equipment activation. Notify operations when maintenance procedures are complete and equipment functionality is restored and tested.

If on-site maintenance must be performed (in other words, if equipment cannot be transported to a controlled maintenance facility) isolate the location of the maintenance to prevent unaware personnel from inadvertently exposing themselves to a hazard.

All spare parts must meet or exceed OEM specifications in order to maintain equipment integrity, especially protective equipment.

Your equipment uses materials that may be harmful to the environment if improperly disposed of. Dispose of all materials according to your company's environmental protection regulations.

Maintenance activities may generate electrostatic charge. McCoy recommends grounding the equipment using the supplied ground line before beginning maintenance in order to reduce the possibility of damage to sensitive electronic components.



CAUTION

GROUND EQUIPMENT BEFORE BEGINNING MAINTENANCE ACTIVITIES

5.1 CLEANING

Use of a dry cloth on the WinCatt™ enclosure may generate a harmful electrostatic charge. Clean the enclosure using a damp cloth only. Do not use solvents on the WinCatt™ enclosure.

5.2 INSPECTIONS

Inspect all connectors for contamination or damage. Do not use the unit if connectors are cracked, if the pins are bent or show signs of electrical arcing, or there is visible severe damage (cuts, crushed insulators, etc.) to the cables.

Inspect the ground connections at the enclosure, and at the ground clamp. The ground connections must be tight, secure, and in good condition.

When using an ATEX enclosure use the supplied key to unlatch the four cam-locks on the back door. Fully open the back door and inspect the seal around the door to ensure it is fully intact and air-tight.

5.2 INSPECTIONS (CONTINUED):

Ensure the seal remains pliable and is not degrading due to dry rot. While the rear door is open inspect the interior components. Canned, pressurized air may be used to blow dust from internal components if required. Close the door and use the supplied key to firmly engage all four cam-locks.

Use the supplied key to unlatch the single cam-locks on the front door of the purge controller. Fully open the door and inspect the seal around the door to ensure it is fully intact and air-tight. Ensure the seal remains pliable and is not degrading due to dry rot. While the front door is open inspect the interior components. Canned, pressurized air may be used to blow dust from internal components if required. Close the door and use the supplied key to firmly engage the cam-lock.

Inspect the air line supplying the filtration unit, and the air line linking the filtration unit to the enclosure. Replace air lines that are leaking, or have suffered visible damage (cut, cracked, kinked, etc).

Check all the bolts and fasteners, ensuring they are snug. Use a wrench or screwdriver (where applicable) to tighten loose fasteners.

5.3 LOAD CELL REFERENCE CHECK

The following steps define a process for determining if your torque measurement system is correctly measuring and indicating within an expected range. This procedure is best suited for performing in a shop or location removed from the drill floor, within range of a crane. This is a reference check and not a calibration. Calibrations must be performed at an authorized calibration facility. See section 3 for specific connection instructions if required. This procedure assumes a working knowledge of the WINCATT® 7 software.

NOTICE

THIS PROCEDURE ASSUMES A WORKING KNOWLEDGE OF THE WINCATT® 7 SOFTWARE

Tension Load Cell

1. Locate a known weight in the range of approximately 500 to 1000 lbs (227 to 455 kg).
2. Connect the tension load cell to the junction box. Ensure the hydraulic line between the two is not crimped.
3. Connect the CT cable between the junction box and the WINCATT® enclosure.
4. Connect power to the WINCATT® enclosure, and power up the system. Allow Windows to load, then start the WINCATT® software.
5. Select "Resume Old Job" or, if in Bucking Mode, select "Start" to proceed to the Data Acquisition screen.
6. Select "Utility Menu" to launch the Utility Menu screen. From the Utility Menu select "Hardware" to launch the Hardware screen. Double-check that the arm length displayed matches the stated equipment arm length.
7. Suspend the load cell, piston side up, from a crane capable of supporting the known weight described in Step 1.
8. Connect the rod side of the load cell to the known weight, and use the crane to hoist the load cell and weight from the surface to hang freely.
9. Perform a simple calculation to determine the expected indication on the torque gauge based on the known hoisted weight.

Imperial calculation:

$$[\text{KNOWN WEIGHT}] \times [\text{ARM LENGTH (in feet)}]$$

For example, if the arm length is 36 inches and the hoisted weight is 1000 lbs the calculation is:

$$1000 \times (36/12) = 3000$$

Therefore, the expected Imperial torque output indication in the torque output field should be approximately 3000 lbs-ft.

Metric calculation:

$$[\text{KNOWN WEIGHT (in kg)}] \times [\text{ARM LENGTH (in feet)}] \times [1.356].$$

For example, using the weights in the Imperial calculation the Metric calculation is:

$$[453.6 \text{ kg} \times 2.205] \times [32 / 12] \times [1.356] = 4068.8$$

Therefore, the expected Metric torque output indication in the torque output field should be approximately 4069 Nm.

5.3 LOAD CELL REFERENCE CHECK (CONTINUED):Compression Load Cell

1. Locate a known weight in the range of approximately 500 to 1000 lbs (227 to 455 kg).
2. Connect the compression load cell to the junction box. Ensure the hydraulic line between the two is not crimped.
3. Connect the CT cable between the junction box and the WINCATT® enclosure.
4. Connect power to the WINCATT® enclosure, and power up the system. Allow Windows to load, then start the WINCATT® software.
5. Select "Resume Old Job" or, if in Bucking Mode, select "Start" to proceed to the Data Acquisition screen.
6. Select "Utility Menu" to launch the Utility Menu screen. From the Utility Menu select "Hardware" to launch the Hardware screen. Double-check that the arm length displayed matches the stated equipment arm length.
7. Place the compression load cell piston side down on a sturdy surface such as a concrete shop floor.
8. Use a crane to hoist the known weight on to the rod end of the compression load cell. This is a small area, so an ideal known weight should be relatively small and dense. A block of solid metal or concrete is preferred. The weight must be centered exactly on the rod end of the load cell to ensure even and accurate compression. Do not use a tall unrestrained known weight that could topple. Do not disconnect the known weight from the crane, but ensure the crane exerts no upward force on the weight. The attached crane prevents an un-centered weight from toppling.
9. Perform a simple calculation to determine the expected indication on the torque gauge based on the known weight placed on the load cell.

Imperial calculation:

$$[\text{KNOWN WEIGHT}] \times [\text{ARM LENGTH (in feet)}]$$

For example, if the arm length is 36 inches and the hoisted weight is 1000 lbs the calculation is:

$$1000 \times (36/12) = 3000$$

Therefore, the expected Imperial torque output indication in the torque output field should be approximately 3000 lbs-ft.

Metric calculation:

$$[\text{KNOWN WEIGHT (in kg)}] \times [\text{ARM LENGTH (in feet)}] \times [1.356].$$

For example, using the weights in the Imperial calculation the Metric calculation is:

$$[453.6 \text{ kg} \times 2.205] \times [32 / 12] \times [1.356] = 4068.8$$

Therefore, the expected Metric torque output indication in the torque output field should be approximately 4069 Nm.

5.4 AIR FILTRATION MAINTENANCE

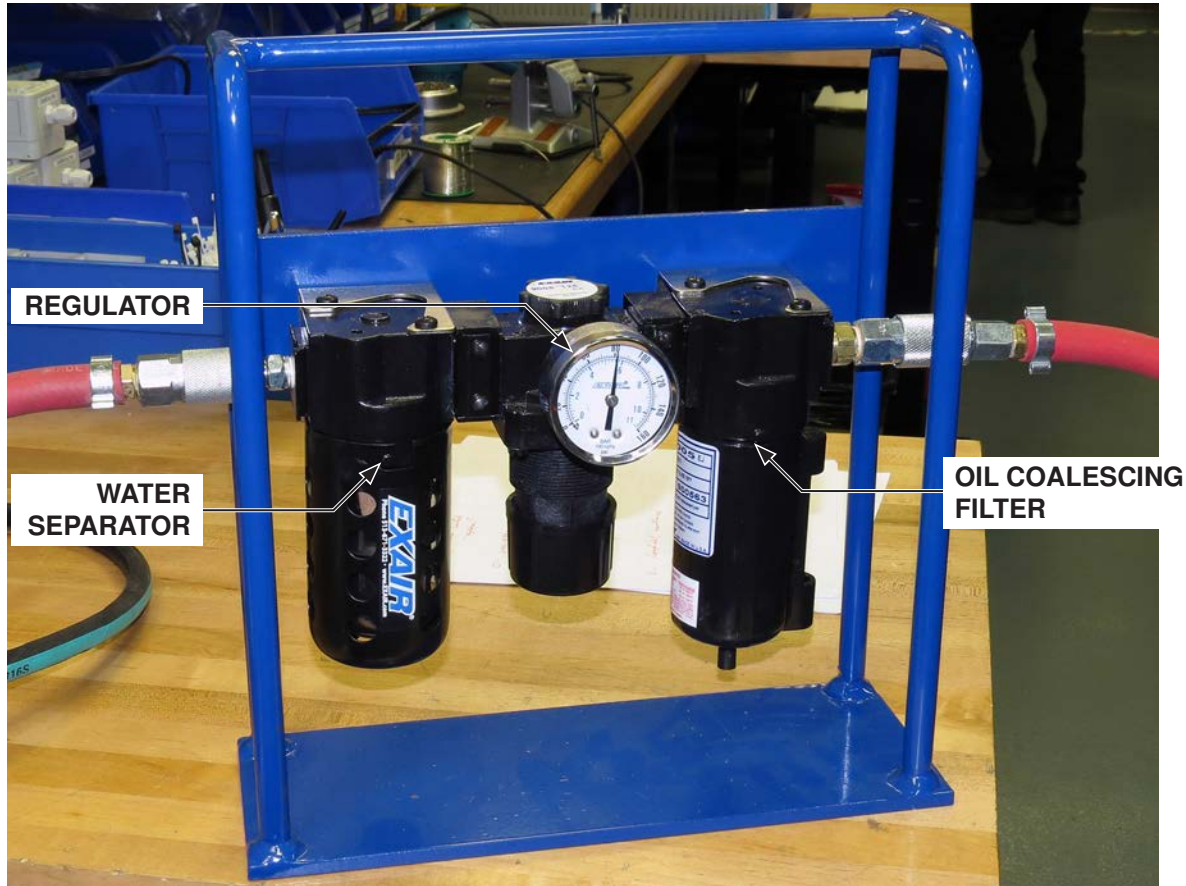

Illustration 5.4.1: Supply Air Filter Assembly

5.4.1 Pressure Regulator Maintenance

Perform maintenance on the air pressure regulator upon discovery of air leaks or pressure “creep”.

Depressurize the air supply. Remove the bottom cap and inspect the valve seat for damage or wear. Inspect the seat in the head casting for foreign material or damage. Clean components with kerosene, and dry with dry air. Replace damage components if required - contact McCoy for information on spare parts.

If leaks persist remove the bonnet and inspect diaphragm and diaphragm seat for damage, wear, or foreign material contamination.

5.4.2 Water Separator

Periodically drain off accumulated sludge and moisture according to your established preventive maintenance schedule. More frequent draining may be required if the air supply is excessively wet or dirty - do not allow sediment to fill above the lower baffle.

Occasional washing of the internal filter element may be required in order to maintain filter efficiency. Depressurize the air supply system and unscrew the filter canister (bowl) to remove. Unscrew the element from the head, and wash in clean Varsol (or similar) cleaning solvent. Thoroughly dry the filter element following cleaning. Wash the filter bowl with soapy water, rinse thoroughly with clear water, and dry completely before reinstallation.

Inspect the o-ring prior to reinstallation, and replace if damaged or distorted.

Thread the clean filter element back on to the head, followed by the filter canister (bowl).

5.4.3 Oil Coalescing Filter

A pressure drop across the filter of 10 psi or more indicates the filter element indicates that the filter has been excessively contaminated with dirt and requires replacement. Depressurize the air supply system and unscrew the filter canister (bowl) to remove. Unscrew the coalescing filter element from the head and discard according to your company’s disposal protocols. Inspect the o-ring for damage or distortion, and replace if required.



SECTION 6: PARTS & ASSEMBLIES









**This page intentionally
left blank**

Recommended Spare parts for 60-6000-14

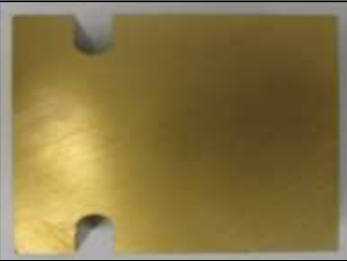
Item #	QTY	Part #	Description	Image
1	1	60-0068	BEI SHAFT ENCODER 100 COUNT	
2	1	60-0001	LONG SHAFT ENCODER MOUNT	
3	1	60-0175	C/T CABLE 50FT C/W ENDS	
4	1	60-0394	ENCODER CABLE 10FT C/W CONNECTORS	
5	1	60-0375	POWER CABLE C/W 15A PLUG 10FT	
6	1	60-0368	DUMP VALVE CABLE C/W CONNECTORS 10FT	
7	1	60-0385	REMOTE JUNCTION BOX – TRANSDUCER	

Recommended Spare parts for 60-6000-14

8	1	60-0322	DUMP VALVE CARTRIDGE	
9	1	60-0320	24V DC COIL	
10	1	60-0323	ALUMINUM BODY	
11	1	60-0470	DUMP VALVE ASSEMBLY	
12	1	60-0336	NEMA4 SEALED KEYBOARD MOUSE USB	
13	1	60-6019	TABLET PEN	
14	1	60-0343	RIBBON CABLE	

Recommended Spare parts for 60-6000-14

15	1	60-0342	DAC HUB FOR WINDOWS 8 TABLET	
16	1	10-0008TW	TENSION LOAD CELL	
17	1	10-0008C	COMPRESSION LOAD CELL	
18	1	60-0035	5 AMP FUSE	
19	1	60-0033	1 AMP FUSE	

Recommended Spare parts for 60-6000-14

20	1	60-0350	CONTROLLER CARD	
21	1	60-9565	FAN FOR TABLET	
22	1	60-0331	CONNECTOR TO JOIN 2 CT CABLES	
23	1	60-0612	MINI USB 2.0 HUB (4 PORT)	
24	1	60-0100	24V DC Power Supply Small	
25	1	60-6010WT310	TOSHIBA WINDOWS 8 TABLET w? WINCATT 7 SOFTWARE	

Recommended Spare parts for 60-6000ATEX-FARR Explosion Proof System

Item #	QTY	Part #	Description	Image
1	1	60-0074	ATEX SHAFT ENCODER 100 COUNT	
2	1	60-0073	ATEX SHAFT ENCODER 200 COUNT	
3	1	60-0001A	SHAFT ENCODER MOUNT	
4	1	60-0481-MAN	POWER CABLE W/ ATEX CONNECTORS	
5	1	60-0175	C/T CABLE 50FT C/W ENDS	
6	1	60-0394	ENCODER CABLE 10FT C/W CONNECTORS	

7	1	60-0478-MAN	DUMP VALVE W/ ATEX CONNECTORS (DOES NOT INCLUDE 60-0478-WF)	
8	1	60-0478-WF	DUMP VALVE COIL/BLOCK/CARTRIDGE ASSEMBLY	
9	1	60-0432	REMOTE JUNCTION BOX – IS HYDRAULIC	
10	1	60-6010	TABLET PC	
11	5	60-0033	1 AMP FUSE	

12	5	60-0035	5 AMP FUSE	
13	1	10-0008TW	TENSION LOAD CELL	
14	1	10-0008C	COMPRESSION LOAD CELL	
15	1	60-0336	NEMA4 SEALED KEYBOARD MOUSE USB	
16	2	60-6019	TABLET PEN	
17	1	60-0335	PCMCIA CABLE	

18	1	60-0357	PCMCIA DAC CARD FOR XP (LAPTOP)	
19	1	60-0350	CONTROLLER CARD	
20	1	60-0100	24V DC POWER SUPPLY	
21	2	60-0005	MK72 IS POWER SUPPLY	
22	1	60-0006	MTL5532 IS ELECTRONIC BARRIER	

23	1	60-0004	MTL5041 IS ELECTRONIC BARRIER			
24	1	60-0206	Thermal Sensor		